



Power Anytime, Anywhere

Tesla™ TI2560 12-24 GPU Ground Power Unit

User Manual



Built Smart...Proven Tough

Tesla Industries, Inc.
101 Centerpoint Blvd.
New Castle, DE 19720
(302) 324-8910 Phone
(302) 324-8912 Fax
www.teslainsd.com

**NOTE: All users must read this entire manual prior
to operating the TI2560 12-24 GPU.**

The TI2560 12-24 GPU is a limited maintenance-free and sealed unit. No repairs are authorized. Warranty will be voided if unit is tampered with in any way, or if unauthorized repairs are made. For technical support please contact:

TESLA™ INDUSTRIES INCORPORATED

101 CENTERPOINT BLVD.

CENTERPOINT INDUSTRIAL PARK

NEW CASTLE, DELAWARE 19720

PHONE: (302) 324-8910

FAX: (302) 324-8912

WEBSITE: www.teslaind.com

EMAIL: tesla1@teslaind.com



CAUTION

Shock Hazard Potential

Improper use or failure to follow instructions in this user manual can result in unit damage and/or injury or death by electrical shock.

Any attempts to open or examine the inside of the TI2560 12-24 GPU via a tool or device (borescope, probe, etc.) can result in unit failure and/or injury by electrical shock. This GPU is maintenance free and should not be opened or disassembled for any reason.

Always protect the unit from short circuit.

Shipping Hazards: The TI2560 12-24 GPU contains sealed, dry cell rechargeable batteries that do not pose a shipping hazard.

No part of this manual may be reproduced or transmitted in any form or by any means, electronic or mechanical, including photocopying, recording, or any information storage and retrieval system, without prior written permission from Tesla™ Industries, Inc.

Copyright © 2015 by Tesla™ Industries, Incorporated. All rights reserved.



INFORMATION ONLY - PLEASE READ SECTION X

SECTION I - PRODUCT AND MANUFACTURER IDENTITY

Product Identity:

Tesla[®]™ Turbo Start[®]™ Ground Power Unit (GPU) and Micro Power Unit (MPU) Containing Dry Cell (Starved Electrolyte) Batteries Used on Aviation/Military Application

Manufacturer's Name and Address:

Tesla Industries Inc.
101 Centerpoint Blvd.
New Castle, Delaware 19720

Emergency Telephone Number:

(302)324-8910
Fax: (302)324-8912
www.Teslainsd.com

SECTION II - INGREDIENTS

Hazardous Components	CAS #	OSHA PEL-TWA	% (By weight)
Lead	7439-92-1	50 µg/m ³	45 - 60 %
Lead Dioxide	1309-60-0	50 µg/m ³	15 - 25%
Sulfuric Acid Electrolyte	7664-93-9	1.0 mg/m ³	15 - 20%
Non-Hazardous Materials	N/A	N/A	5 - 10%

SECTION III - PHYSICAL/CHEMICAL CHARACTERISTICS

Boiling Point - N/A

Specific Gravity (H₂O=1) - NA

Vapor Pressure (mm Hg.) - N/A

Melting Point - N/A

Solubility in Water - N/A

Appearance & Color - N/A

SECTION IV - FIRE & EXPLOSION HAZARD DATA

Flash Point (Method Used): N/A

Flammable Limits: N/A

LEL: N/A

UEL: N/A

Extinguishing Media: Multipurpose Dry chemical CO₂ or water spray.

Special Fire Fighting Procedures: Cool GPU/MPU exterior to prevent rupture. Acid mists and vapors in a fire are toxic and corrosive.

Unusual Fire and Explosion Hazards: Hydrogen gas may be produced and may explode if ignited. Remove all sources of ignition.

SECTION V - REACTIVITY DATA AND SHIPPING/HANDLING ELECTRICAL SAFETY

Stability: Stable

Conditions to Avoid: Avoid shorting, high levels of short circuit current can be developed across the battery terminals. Do not rest tools or cables on the battery. Avoid over-charging. Use only approved charging methods. Do not charge in gas tight containers.

SECTION VI - HEALTH HAZARD DATA

Routes of Entry: N/A

Health Hazards (Acute & Chronic): N/A

Emergency & First Aid Procedures:

Battery contains acid electrolyte, which is absorbed in the separator material. If battery case is punctured, completely flush any released material from skin or eyes with water.

Proposition 65:

Warning: Battery posts, terminals and related accessories contain lead and lead compounds, chemicals known to the State of California to cause cancer and reproductive harm. Batteries also contain other chemical known to the State of California to cause cancer. Wash hands after handling

SECTION VII - PRECAUTIONS FOR SAFE HANDLING & USE

Steps to be taken in case material is released or spilled

Avoid contact with acid materials. Use soda ash or lime to neutralize. Flush with water.

Waste Disposal Method

Dispose of in accordance with Federal, State, & Local Regulations. Do not incinerate. Batteries should be shipped to a reclamation facility for recovery of the metal and plastic components as the proper method of waste management. Contact distributor for appropriate product return procedures.

SECTION VIII - CONTROL MEASURES - NOT APPLICABLE

SECTION IX - OTHER REGULATORY INFORMATION

Tesla™ Industries GPU/MPU batteries are sealed electrolyte batteries, which means the electrolyte is absorbed in the separator material. The batteries are also sealed.

NFPA Hazard Rating for Sulfuric Acid:

Health (Blue) = 3

Flammability (Red) = 0

Reactivity (Yellow) = 2

Sulfuric Acid is Water Reactive if concentrated.

U.S. DOT: Tesla™ Industries GPU/MPU batteries are classified as Nonspillable. They have been tested and meet the nonspillable criteria listed in 49 CFR § 173.159(f) and 173.159a(d)(1).

Nonspillable batteries are excepted from 49 CFR Subchapter C requirements, provided that the following criteria are met:

1. The batteries must be securely packed in strong outer packagings and meet the requirements of 49 CFR § 173.159a.
2. The batteries' terminals must be protected against short circuit.
3. Each battery and their out packaging must be plainly and durably marked "NONSPILLABLE" or "NONSPILLABLE BATTERY".

The exception from 49 CFR, Subchapter C means shipping papers need not show proper shipping name, hazard class, UN number and packing group. Hazardous labels are not required when transporting a nonspillable battery.

IATA: Tesla™ Industries GPU/MPU batteries have been tested and meet the nonspillable criteria listed in IATA Packing Instruction 872 and Special Provision A67. Nonspillable batteries must be packed according to IATA Packing Instructions 872. This means shipping papers need not show proper shipping name, hazard class, UN number and packing group. Hazardous labels are not required when transporting a nonspillable battery.

These batteries are excepted from all IATA regulations provided that the batteries are packed in a suitable out packaging and their terminals are protected against short circuits.

IMDG: Tesla™ Industries GPU/MPU batteries have been tested and meet the nonspillable criteria listed in Special Provision 238. Non-spillable batteries must be packed according to IMDG Packing Instruction P003. This means shipping papers need not show proper shipping name, hazard class, UN number and packing group. Hazardous labels are not required when transporting a nonspillable battery. These batteries are excepted from all IMDG codes provided that the batteries are packed in a suitable out packaging and their terminals are protected against short circuits per PP16.

RCRA: Spent lead-acid batteries are not regulated as hazardous waste by the EPA when recycled, however state and international regulations may vary.

CERCLA (Superfund) and EPCRA:

- (a) Reportable Quantity (RQ) for spilled 100% sulfuric acid under CERCLA (Superfund) and EPCRA (Emergency Planning Community Right to Know Act) is 1,000 lbs. State and local reportable quantities for spilled sulfuric acid may vary.
- (b) Sulfuric acid is a listed "Extremely Hazardous Substance" under EPCRA, with a Threshold Planning Quantity (TPQ) of 1,000 lbs.
- (c) EPCRA Section 302 notification is required if 1,000 lbs. or more of sulfuric acid is present at one site.
- (d) EPCRA Section 312 Tier 2 reporting is required for batteries if sulfuric acid is present in quantities of 500 lbs. or more and/or if lead is present in quantities of 10,000 lbs. or more.
- (e) Supplier Notification: this product contains toxic chemicals, which may be reportable under EPCRA Section 313 Toxic Chemical Release inventory (Form R) requirements.

If you are a manufacturing facility under SIC codes 20 through 39, the following information is provided to enable you to complete the required reports:

<u>Toxic Chemicals</u>	<u>CAS Number</u>	<u>Approximate % by Wt.</u>
Lead	7439-92-1	45-60
Sulfuric Acid	7664-93-9	15-20

SECTION X - ADDITIONAL INFORMATION

The Tesla™ Industries GPU/MPU sealed lead acid battery is determined to be an "article" according to the OSHA Hazard Communication Standard and is thereby excluded from any requirements of the standard. The Material Safety Data Sheet is therefore supplied for informational purposes only.

The information and recommendations contained herein have been compiled from sources believed to be reliable and represent current opinion on the subject. No warranty, guarantee, or representation is made by Tesla™ Industries, as to the absolute correctness or sufficiency of any representation contained herein and Tesla™ Industries assumes no responsibility in connection therewith, nor can it be assumed that all acceptable safety measures are contained herein, or that additional measures may not be required under particular or exceptional conditions or circumstances.

*N/A or Not Applicable - Not applicable for finished product used in normal conditions.

Table of Contents

Section 1 – Safety Review	1
1.1 – Safety Notices	1
1.2 – Symbols	1
1.3 – Hazards	2
1.4 – Important Safety Precautions	3
1.5 – Extreme Environments	3
Section 2 – Product Overview	4
2.1 – Introduction	4
2.2 – Indication of Terms: Shall, Should, and May	4
2.3 – Front Panel Overview	5
2.4 – General Specifications	6
2.5 – Physical Dimensions	7
2.6 – Airflow Ports	7
2.7 – Operating Position	8
2.8 – AC Input Circuit Breakers	9
2.9 – AC Input Connector	9
2.10 – 24 Volt Output Connector	10
2.11 – 12 Volt Output Connector	10
2.12 – Input Voltage Selector Switch	10-11
2.13 – “Push to Test” Button and LED Status Indicator	12
Section 3 – Operating Procedures	13
3.1 – Operating Procedures	13
3.2 – General	13
3.3 – Operating Limits and Restrictions	13
3.4 – Performance	13
3.5 – Engine Starting Power	13
3.6 – Temperature Specifications	14
3.7 – Environmental	15
3.8 – Normal Functional Test Procedures	16-17
3.9 – Pre-Operation	18
3.10 – Transporting Unit	18
3.11 – Regulated 28.5 Vdc Ground Power	19-20
3.12 – Regulated AC Power	20-21
3.13 – Charging Unit	21

Section 4 – Post Operation	22
4.1 – General	22
4.2 – After Use	22
4.3 – Power Cell Recharge	22-23
Section 5 – Unit Care and Maintenance	24
5.1 – Unit Care	24
5.2 – Unit Servicing	25
5.3 – Packaging and Shipping	25
Section 6 – Troubleshooting and FAQ	26
6.1 – Frequently Asked Questions	26-27
6.2 – Basic Usage/Operation Questions	28
6.3 – Basic Troubleshooting	29-30
Section 7 – Performance Data	31
7.1 – Purpose	31
7.2 – General	31
7.3 – Data Basis	31
7.4 – Specific Conditions	31
7.5 – General Conditions	31
7.6 – Temperature Conversion Chart	32
7.7 – Output Voltage	33
7.8 – Maximum Output Current	33
7.8 – 12 Vdc Output Loading Curves	34
Section 8 – Optional Accessories	36
8.1 – Shipping Case	36
8.2 – GPU Protective Covers	36
8.3 – Tesla™ AC Line Cords	36
8.4 – Cobra™ DC Replacement Contacts and Tools	37
8.5 – GPU Tires	37
Appendix A	38-42
Repair Request Form	43

Abbreviations and Symbols

Abbreviations that may be used within the text, headings and titles of this manual.

LIST OF ABBREVIATIONS



Abbreviation **Definition**

ac	Alternating Current
AFT	Airflow Technology
AWG	American Wire Gauge
amp or A	Ampere
cont	Continuous
°C	Degree Celsius
°F	Degree Fahrenheit
dc	Direct Current
EFF	Efficiency
ft	Feet
FWD	Forward
GPU	Ground Power Unit
Hr	Hour
Hz	Hertz
kg	Kilograms
kHz	Kilohertz
kW	Kilowatts
LED	Light Emitting Diode
max	Maximum
MΩ	megaohm
min	Minimum
MPU	Micro Power Unit
NEMA	National Electrical Manufacturers Association
Ω	ohm
PF	power factor
PFC	power factor correction
rms	root-mean-square
THD	Total Harmonic Distortion
TMDE	Test, Measurement, & Diagnostic Equipment
UAV	Unmanned aerial vehicle
Vac	Volts, Alternating Current
Vdc	Volts, Direct Current
W	watts

Section 1 – Safety Review

1.1 - Safety Notices

Safety notices appear throughout this manual to alert the user to important information regarding proper installation, operation, maintenance and storage of the unit. These notices, as illustrated below, contain a key word that indicates the level of hazard and a triangular icon that indicates the specific type of hazard.

 WARNING	Indicates a condition, operating procedure or practice, which if not adhered to could result in serious injury or death.
 CAUTION	Indicates a condition or operating procedure, which if not strictly adhered to could result in damage or destruction of equipment.
 NOTE	Indicates a condition, operating procedure or practice, which is essential to highlight.

1.2 - Symbols

The following symbols will appear within the warning triangles to alert the user to the specific type of danger or hazard.



Figure 1.2.1 – Different types of hazard and caution symbols

1.3 – Hazards



WARNING

Shock Hazard Potential

Severe injury or death from electrical shock may occur if either the user or the unit is wet while the operating unit is connected to a power source. Be sure to disconnect ac power from the ac source if the unit has come into contact with water. If AC Input Circuit Breaker has tripped due to water infiltration, DO NOT try to reset it with the ac line voltage attached.



WARNING

Shock Hazard Potential

Severe injury or death from electrical shock can occur when damp electrical plugs are connected to the unit. Make sure the unit is turned off before making any connections. Failure to use proper grounding can cause potential shock hazard! In different countries, the power cord may require the use of a plug adapter to achieve plug style compatibility for operation. Use only adapters with proper grounding mechanism.

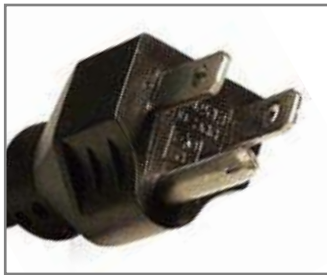

Figure 1.3.1 – Proper Ground Grounded Plug with Grounding Pin



Figure 1.3.2 – Proper Ground Adapter with Grounding Mechanism (Secured to Outlet)



Figure 1.3.3 – Improper Ground Plug with No Grounding Pin



CAUTION

Unit Damage Potential

The unit will be damaged if unapproved ac power is applied. Check the Input Voltage Selector Switch window (outlined in blue) to ensure the switch setting (115V or 230V) matches the ac power source (hangar wall, flight line ac power) prior to connecting the unit for recharging.



Figure 1.3.4 – TI2560 12-24 GPU Input Voltage Selector Switch

1.4 – Important Safety Precautions



WARNING

Fire/Explosion Hazard Potential

Severe injury or death from fire or explosion can occur if electrical sparks are produced near fuel vapors. DO NOT CONNECT ac power supply WHILE FUELING. AC power functions of unit shall not be operated during any fuel handling operation. Power output is restricted to dc power only.

1.5 – Extreme Environments



CAUTION

Unit Damage Potential

The unit is equipped with a charger temperature switch that automatically disables the unit when the internal temperature exceeds 150 °F (65 °C). This protects the unit from overheating and damage. If the unit shuts down, move the unit into a cooler environment such as shade or air conditioning when possible. Perform a full function test after the unit has been allowed to cool prior to use.

Section 2 – Product Overview

2.1 – Introduction

Thank you and congratulations on the purchase of your new TI2560 12-24 GPU Ground Power Unit.

This manual contains the complete operating instructions and procedures for the TI2560-12-24 Ground Power Unit. The TI2560 12-24 GPU has been designed to serve as a stand-alone source of DC electrical power for aircraft systems and ground support maintenance operations. Using a single 120 Vac power source, the TI2560 12-24 GPU will provide regulated outputs of 14.25 Vdc at 20 amps continuous and 28.5 Vdc at 25 amps continuous. For vehicle and aircraft starting, the 12 Vdc and 24 Vdc outputs can deliver up to 3000 peak amps.

The unit's high-capacity power cells and circuitry are encased in a rugged enclosure. This internal circuitry incorporates an intelligent recharging system that allows the TI2560 12-24 GPU to rapidly recharge from any standard 110-130 Vac outlet receptacle. The unit also comes equipped with independent dual outputs and built-in Charge Status Meters (via the "Push to Test" button) that also serve as recharge state indicators for both dc outputs.

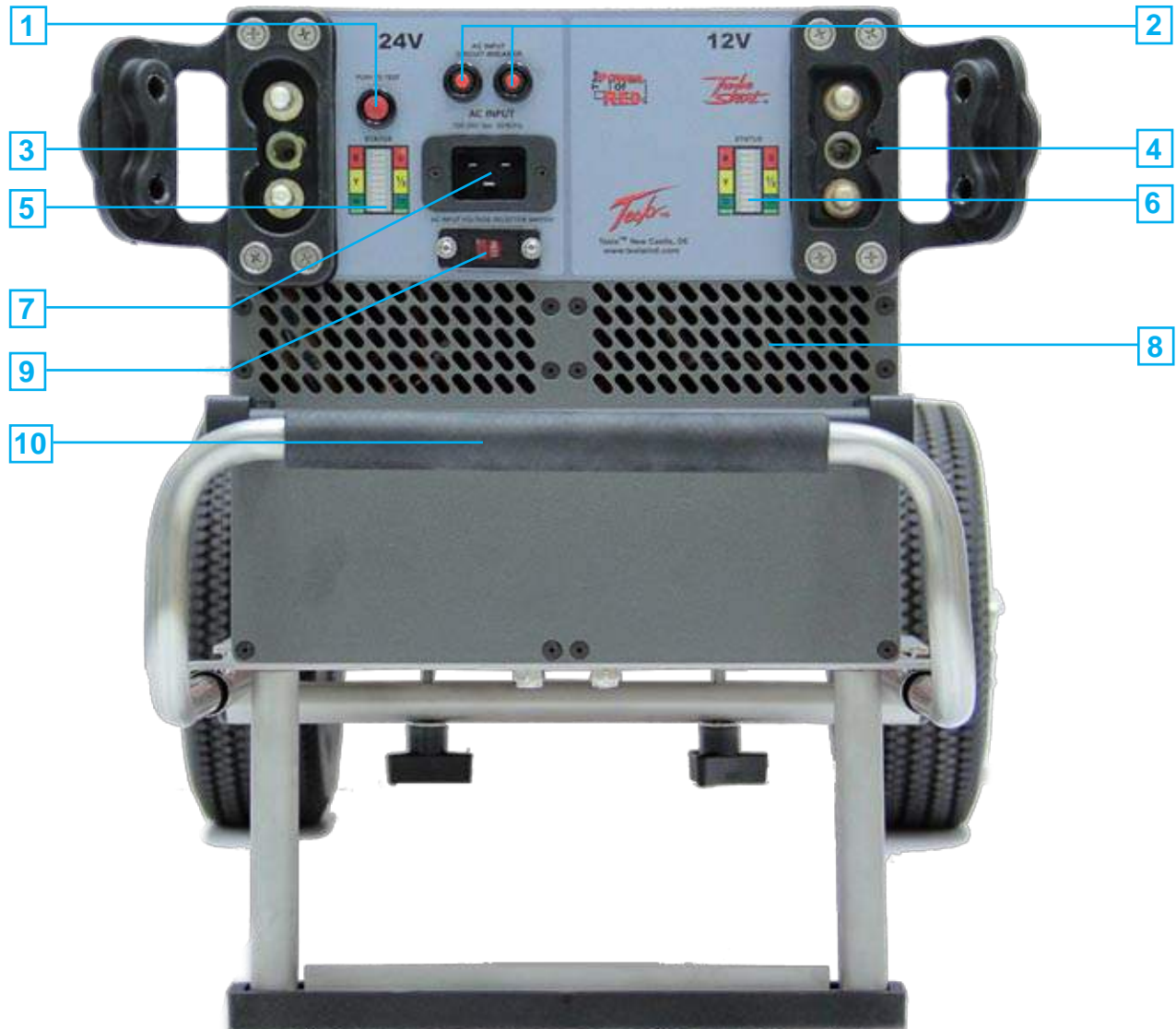

Figure 2.1.1 – TI2560 12-24 GPU

2.2 – Indication of Terms: Shall, Should, and May

Within this technical manual the word "shall" is used to indicate a mandatory requirement for proper operation and warranty purposes. The word "should" is used to indicate a non-mandatory but preferred method of accomplishment. The word "may" is used to indicate an acceptable method of accomplishment.

2.3 – Front Panel Overview



1. **“Push to Test” Button** – Displays current battery charge state when pressed.
2. **AC Input Circuit Breakers** – Trip if over-current fault condition occurs.
3. **24 Vdc Output Connector**
4. **12 Vdc Output Connector**
5. **24 Vdc Capacity Meter** – Indicates the 24V battery charge state/power output status.
6. **12 Vdc Capacity Meter** – Indicates the 12V battery charge state/power output status.
7. **AC Input Connector** – Connects to standard 110-130 Vac line voltage.
8. **Air Intake Ports** – Provide airflow for cooling internal electronics.
9. **Input Voltage Selector Switch** - Allows Unit to operate within voltage range of either 100-130 Vac or 200 260 Vac.
10. **Telescopic Handle** – Allows for easy transport of unit.

2.4 – General Specifications

Electrical

AC Input:

- Operates and charges from Single Phase 100-260 Vac 50/60 Hz
- 14.7 amps @ 120 Vac 60 Hz

Power Cell:

- Dry, High Rate Discharge, Rechargeable , Maintenance-free

DC Output:

24 Volt Output

- 3000 peak starting amps
- 25 amps continuous @ 28.5 Vdc (when plugged into ac power)
- 71 amp hours (1736 watt hours) with ac power
- 46 amp hours (1024 watt hours) of rechargeable battery power without ac

12 Volt Output

- 3000 peak starting amps
- 20 amps continuous @ 14.25 Vdc (when plugged into ac power)
- 66 amp hours (1309 watt hours) with ac power
- 46 amp hours (1024 watt hours) of rechargeable battery power without ac

Recharge Rate from full discharge:

- **24 Volt:** 115 minutes @ 25 °C
- **12 Volt:** 143 minutes @ 25 °C

Size:

- 37.28" L x 19.25" W x 15.97" H
- 946.91 mm x 488.95 mm x 405.64 mm

Weight

- 181.5 lbs (82.32 kg)

Operating Temperature:

- -40 °C to +60 °C (-40 °F to 140 °F) without ac power
- -40 °C to +55 °C (-40 °F to 131 °F) with ac power

Storage Temperature:

- -65 °C to +105 °C (-85 °F to 221 °F)

Cell Capacity:

- +40 °C 110% ± 05%
- +25 °C 100% ± 05%
- +00 °C 80% ± 05%
- -20 °C 65% ± 10%
- -40 °C 50% ± 10%

2.5 – Physical Dimensions

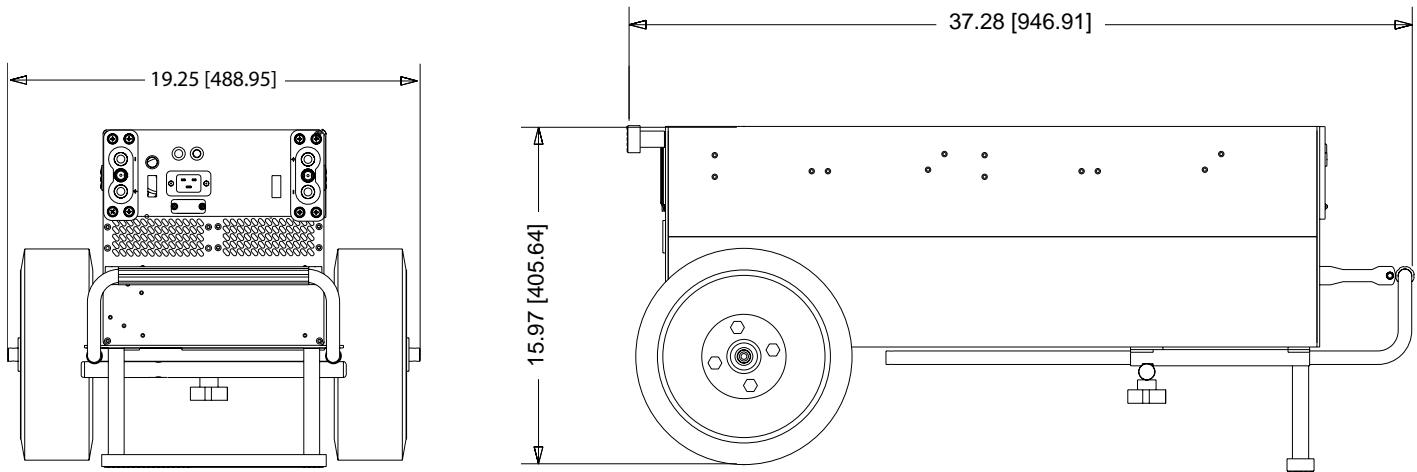

Figure 2.5.1 – TI2560 12-24 GPU physical dimensions

2.6 – Airflow Ports



CAUTION

Damage may occur if the unit's air intake or outlet ports are obstructed. Ensure that ports are clear at all times.

When the TI2560 12-24 GPU is plugged into ac power, the internal cooling system will efficiently regulate unit temperature regardless of load. At room temperature (+77 °F) the exhaust air will not exceed the ambient temperature by more than 5 °F. In more extreme temperatures (greater than 90 °F) the exhaust air will not exceed the ambient temperature by more than 10 °F.

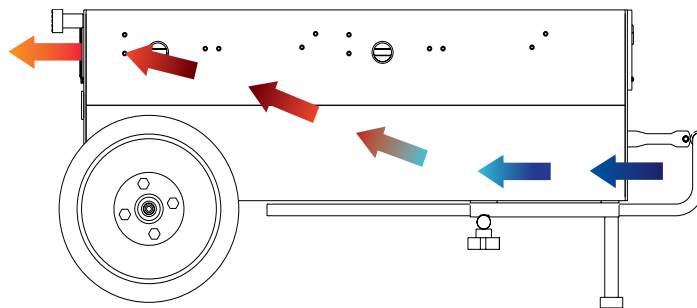
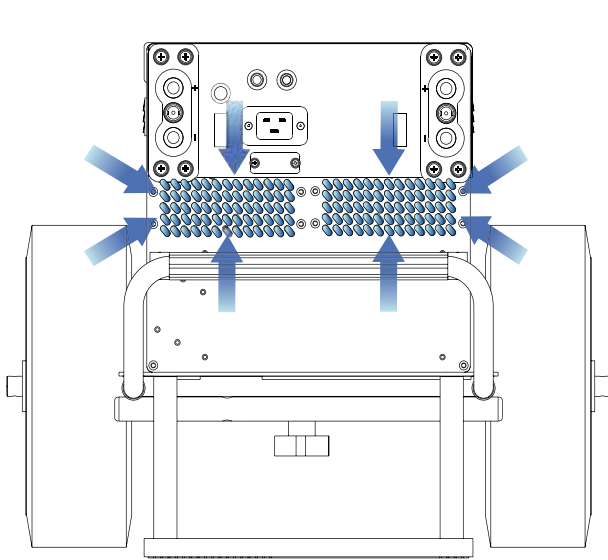

Figure 2.6.1 – Air intake, exhaust ports and internal air circulation

2.7 – Operating Positions

The TI2560 12-24 GPU can be operated in both the horizontal and vertical positions as shown. Make sure that the airflow is not obstructed from air intake and outlet.



Front Inlet

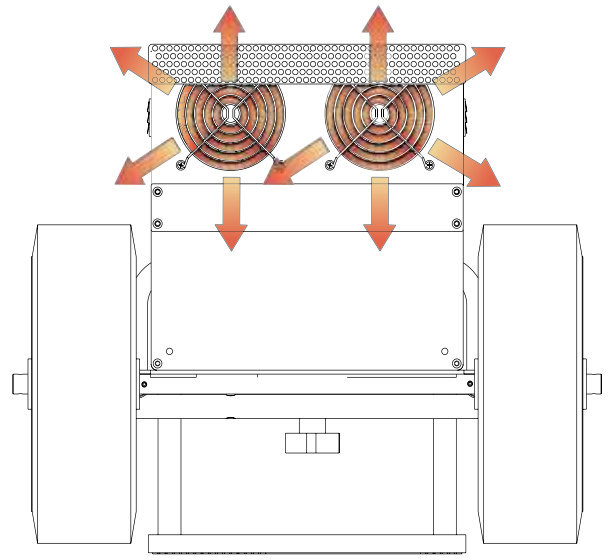

Rear Outlet

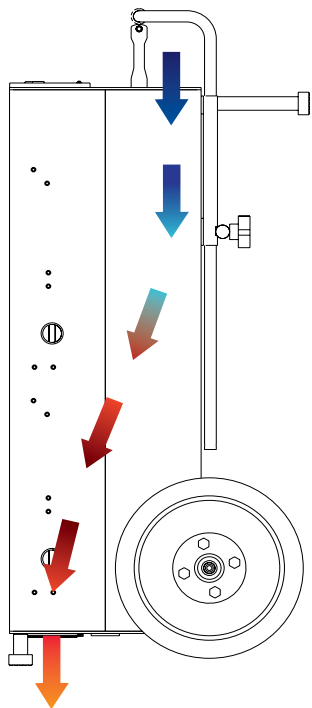

Vertical Position

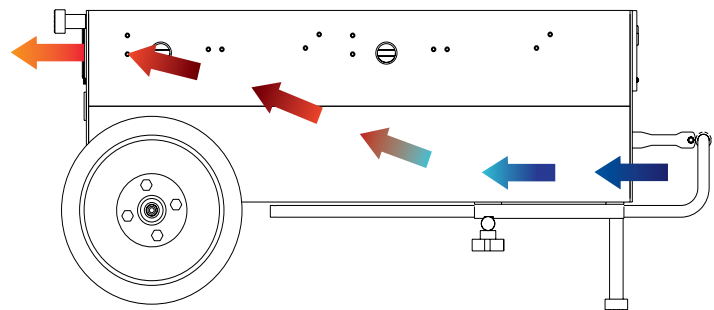

Horizontal Position

2.8 – AC Input Circuit Breaker

The AC Input Circuit Breaker is located above the AC Input Connector. When the circuit breaker has been tripped, the red button will pop out. In the event that the breaker trips:

1. Disconnect the ac and dc connectors.
2. Wait for a minimum of 60 seconds.
3. Reset breaker by pressing red button.
4. Reconnect ac and dc connections to the unit.
5. The unit should power up automatically. If the breaker continues to trip, return the unit to Tesla™ Industries for repair.



Figure 2.8.1 - AC Input Circuit Breaker (outlined in blue)

2.9 – AC Input Connector

The GPU is outfitted with a 3-prong receptacle (see figure 2.9.1 below). The mating cable is keyed and will fasten securely into the AC Input Connector.



Figure 2.9.1 - AC Input Connector (outlined in blue)



Figure 2.10.1 - 24 Vdc Output Connector (outlined in blue) /12 Vdc Output Connector (Outlined in red)

2.10 – 24 Volt Output Connector

The 24 Vdc Output Connector will provide 25 amps continuous @ 28.5 Vdc (when plugged into ac power). When the Output Connector is not in use, cover the receptacle with the protective cover (see Figure 2.10.1). This will protect the Output Connector from dust and foreign matter.

2.11 – 12 Volt Output Connector

The 12 Vdc Output Connector (see Figure 2.10.1) will provide 3000 peak starting amps, and 20 amps continuous @ 14.25 Vdc (when plugged into ac power). When the Output Connector is not in use, cover the receptacle with the protective cover. This will protect the Output Connector from dust and foreign matter. The 12 Volt DC Battery Receptacle is only compatible with the TI2007-503 15' DC Cable with Alligator Clips. A 24 Volt DC Connector will not connect to the 12 Vdc Output Connector.

2.12 – Input Voltage Selector Switch

The Input Voltage Selector Switch allows the unit to operate safely within the expected voltage range of either 100 - 130 Vac or 200 - 260 Vac.



Figure 2.12.1 Input Voltage Selector Switch (outlined in blue)

Changing Input Voltage Selector Switch

To change the input voltage from 115 Vac to 230 Vac, simply follow these steps:

1. With cross tip screwdriver, remove one screw and rotate the clear protective cover to one side. (see figure 2.12.2)
2. Flip the switch to read 230V. (see figure 2.12.3)
3. Rotate cover back into place. Replace and tighten screw.



CAUTION

Do not plug unit into 230 Vac when Input Voltage Selector Switch is set on 115 Vac.



NOTE

The 115 Vac setting accommodates the voltage range of 100-130 Vac. The 230 Vac setting accommodates the voltage range of 200-260 Vac.



Figure 2.12.2 - Unscrew Protective Cover



Figure 2.12.3 - Select Voltage



NOTE

Do not overtighten Selector Shield screws. Be sure star locks are on screws and snug the screw. Overtightening will damage the Selector Shield.

2.13 – “Push to Test” Button and LED Status Indicator

The “Push to Test” button is used to indicate the capacity of the power cells without applying ac input power. It allows the end user to check the status of the power cells. This lets the operator know if there is enough power to perform another engine start, or if the unit has to be connected to ac power to allow it to recharge.

1. Make sure that you wait at least 2 minutes after ac power is applied, or dc power is extracted from the unit, before you press the “Push to Test” button. This will ensure a correct reading.
2. Without ac power input or dc power output, simply press the “Push to Test” button on the faceplate and hold for approximately 2 to 3 seconds.
3. At this time the LED bar graph should light up indicating the status of the power cells.
4. The fan should also operate at this time. If you do not hear the fan running, stop pressing the button and check for any obstructions to the fan.

CAUTION

Never press the “Push to Test” button while the unit is plugged into ac power for recharge, or plugged into aircraft for dc power output.

CAUTION

Never press the “Push to Test” button for more than 5 seconds. This may cause a temperature sensor to temporarily disrupt “Push to Test” function. (If this sensor is tripped, allow ten minutes for unit to cool before operating “Push to Test” button.)

Figure 2.13.1 - Pushing to Test

STATUS	STATUS	STATUS																																																						
<table border="1" style="border-collapse: collapse; width: 100%;"> <tr><td style="background-color: red; color: white;">R</td><td style="width: 20px;"></td><td style="background-color: red; color: white;">0</td></tr> <tr><td style="background-color: yellow;">Y</td><td></td><td style="background-color: yellow;">1/2</td></tr> <tr><td style="background-color: green;">G</td><td></td><td style="background-color: green;">OK</td></tr> <tr><td style="background-color: green;">G</td><td></td><td style="background-color: green;">OK</td></tr> <tr><td style="background-color: green;">G</td><td></td><td style="background-color: green;">OK</td></tr> <tr><td style="background-color: green;">G</td><td></td><td style="background-color: green;">OK</td></tr> </table> <p>Full Charge</p>	R		0	Y		1/2	G		OK	G		OK	G		OK	G		OK	<table border="1" style="border-collapse: collapse; width: 100%;"> <tr><td style="background-color: red; color: white;">R</td><td style="width: 20px;"></td><td style="background-color: red; color: white;">0</td></tr> <tr><td style="background-color: yellow;">Y</td><td style="background-color: yellow; width: 20px;"></td><td style="background-color: yellow;">1/2</td></tr> <tr><td style="background-color: green;">G</td><td style="background-color: green; width: 20px;"></td><td style="background-color: green;">OK</td></tr> <tr><td style="background-color: green;">G</td><td style="background-color: green; width: 20px;"></td><td style="background-color: green;">OK</td></tr> <tr><td style="background-color: green;">G</td><td style="background-color: green; width: 20px;"></td><td style="background-color: green;">OK</td></tr> <tr><td style="background-color: green;">G</td><td style="background-color: green; width: 20px;"></td><td style="background-color: green;">OK</td></tr> </table> <p>Half Charge</p>	R		0	Y		1/2	G		OK	G		OK	G		OK	G		OK	<table border="1" style="border-collapse: collapse; width: 100%;"> <tr><td style="background-color: red; color: white;">R</td><td style="background-color: red; width: 20px;"></td><td style="background-color: red; color: white;">0</td></tr> <tr><td style="background-color: yellow;">Y</td><td style="background-color: yellow; width: 20px;"></td><td style="background-color: yellow;">1/2</td></tr> <tr><td style="background-color: green;">G</td><td style="background-color: green; width: 20px;"></td><td style="background-color: green;">OK</td></tr> <tr><td style="background-color: green;">G</td><td style="background-color: green; width: 20px;"></td><td style="background-color: green;">OK</td></tr> <tr><td style="background-color: green;">G</td><td style="background-color: green; width: 20px;"></td><td style="background-color: green;">OK</td></tr> <tr><td style="background-color: green;">G</td><td style="background-color: green; width: 20px;"></td><td style="background-color: green;">OK</td></tr> </table> <p>No Charge</p>	R		0	Y		1/2	G		OK	G		OK	G		OK	G		OK
R		0																																																						
Y		1/2																																																						
G		OK																																																						
G		OK																																																						
G		OK																																																						
G		OK																																																						
R		0																																																						
Y		1/2																																																						
G		OK																																																						
G		OK																																																						
G		OK																																																						
G		OK																																																						
R		0																																																						
Y		1/2																																																						
G		OK																																																						
G		OK																																																						
G		OK																																																						
G		OK																																																						

12

TI2560 12-24 GPU

Section 3 – Operating Procedures

3.1 – Operating Procedures

This section deals with normal procedures, and includes all steps necessary to ensure safe and efficient operation of the unit.

 NOTE	When the unit is not in use, it should always remain plugged into a suitable ac power source to ensure operational readiness at all times.
---	--

 NOTE	If current demand exceeds 25 amps, converter output voltage will drop below 28.5 Vdc and two or more LED status indicator bars will illuminate. If all LED status indicator bars illuminate, both the converter and power cells are supplying 24 Vdc power output.
---	--

3.2 – General

Correct operation of the unit includes both pre-use and operational checks of the unit. Knowledge of the operating limits, restrictions, performance, unit capabilities and functions is fundamental to correct and safe operation. The operator shall ensure compliance with the instructions in this manual that affect operational safety and the warranty of the unit.

3.3 – Operating Limits and Restrictions

The minimum, maximum and normal operating ranges result from careful engineering and evaluation of test data. These limitations must be adhered to during all phases of operation.

3.4 – Performance

Refer to Section 7, PERFORMANCE DATA to determine the capability of the unit. Consideration must be given to changes in performance resulting from variations in ambient temperature, mode of operation, state of charge (with or without ac power), and aircraft dc bus system inefficiency (voltage drops).

3.5 – Engine Starting Power

Operators should always ensure the unit is charged above 80% prior to ground support engine starting. However, circumstances may exist during use where unit recharge is not readily available and immediate external engine starting power is required. The following provides minimum states of charge necessary to provide ample power for an efficient engine start under specific current load demands.

ENGINE START PEAK CURRENT Requirements

Under 1200 peak starting amps
1200 - 1500 peak starting amps
1500 - 1800 peak starting amps
1800 - 2100 peak starting amps
2100 - 2400 peak starting amps
2400 - 3000 peak starting amps

MINIMUM CHARGE

0-40% charged
40-50% charged
50-60% charged
60-70% charged
70-80% charged
80-100% charged

3.6 – Temperature Specifications

Cold/Hot Soaked Temperature

The ambient temperature that a unit is exposed to for one (1) hour or more establishes the unit’s cold/hot soaked stabilization temperature. If the unit’s cold/hot soaked temperature is outside the normal operating temperature range, the unit must be stabilized prior to operation. For COLD SOAKED temperature stabilization, the unit must be placed in an environment with a temperature above +10°C (+41°F) for 3 hours or a temperature above +20°C (+68°F) for 2 hours. For HOT SOAKED temperature stabilization, the unit must be placed in an environment with a temperature below +38°C (+100°F) for 1 hour.

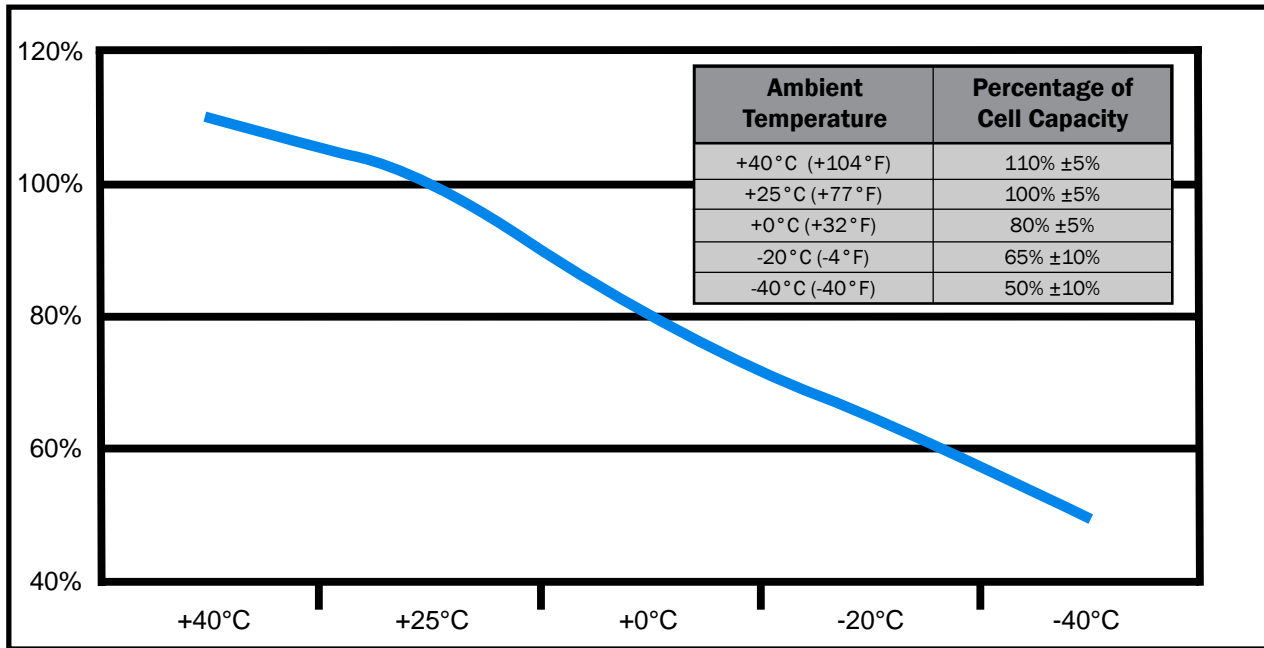



Figure 3.6.1 – Output power capability versus ambient temperature

Hot Soaked or Cold Soaked Definition

Simple terms: When a material is exposed to a change in temperature, its temperature will also change. Some material changes temperature quickly, others slowly. If the ambient temperature changes and is then held constant, the materials temperature will also change until its temperature stabilizes. Once the material temperature has stabilized, it is considered “soaked”.

Example: The unit is moved from the cool shade into the hot sun. The unit’s temperature will increase until it stabilizes. Once stabilized, the unit would be considered “hot soaked”.

	<p>NOTE</p>	<p>The unit is equipped with a temperature switch that automatically disables AC power functions when the internal temperature is above 150°F (65°C). This protects the unit from overheating and damage. If the unit shuts down, move the unit into a cooler climate such as shade or air conditioning when possible. Perform a full function test prior to use after the unit has been allowed to cool.</p>
---	--------------------	---

3.7 – Environmental

 <b style="font-size: 1.2em; margin-left: 10px;">WARNING	Operating any electrical equipment in the presence of moisture creates possible safety hazards and/or potential for equipment damage. Every effort has been made, within the scope of existing technology to prevent foreseeable safety hazards and make the unit moisture resistant to prevent damage or failure.
---	--

If the unit is exposed to moisture, preventive measures and precautions shall be taken to:

- A. Prevent accumulation of moisture on ac and dc connectors/receptacles
- B. Minimize moisture entering forward inlet and aft outlet cooling fan vent ports

Unit inlet and outlet vent ports shall be covered from exposure. Unit shall be kept horizontal. It is recommended that the Tesla™ Protective Rain Cover be fitted onto the unit to guard it from moisture (see Section 8). The limits and operational constraints listed below shall apply for the following environmental (weather) conditions:

Conditions	With Raincover	Without Raincover
Heavy or steady rain: <i>Precipitation falling with an intensity in excess of 0.30 inch (0.76 cm) or continuously between 0.30 and 0.10 inch per hour.</i>	OK	OPERATION NOT RECOMMENDED
Light rain, drizzle or sleet: <i>Precipitation falling on a continuous basis between 0.10 inch and less than 1/50 inch (0.5 mm) per hour</i>	OK	DC OPERATIONS ONLY
Heavy or steady snow: <i>Generally meaning an accumulation between 4 inches and less than 1 inch in a 12 hour period.</i>	OK	OPERATION NOT RECOMMENDED
Light snow: <i>Snow falling intermediately with little or no accumulation.</i>	OK	DC OPERATIONS ONLY
Fog:	OK	OK



Figure 3.7.1 – TI7000-142 GPU Protective Rain Cover

3.8 – Normal Function Test Procedures

This section deals with “normal function” test procedures, and includes all steps necessary to ensure that the unit is operating within specified parameters prior to use. A digital multimeter (an example is shown in Figure 3.8.1) capable of measuring dc and ac voltage and resistance will be required to perform some of the tests. These functional test procedures should become routine.



Figure 3.8.1 – Digital Multimeter

Check Unit for Evidence of Damage

Check for dents, punctures, case distortion or misalignment, and cracked or loose connectors. If no damage is evident, proceed to the next step. If damage is evident, contact Tesla™ Industries, Inc.

Check DC Voltage Reading at DC Receptacle Terminals

To verify that the power cells are fully charged, set the digital multimeter to measure dc voltage. As shown in Figure 3.8.2, place the positive probe (red) on the positive post of the DC Output Connector and the negative probe on the negative post. The multimeter display should read approximately 28.5 Vdc (± 0.5 Vdc) when power cells are fully charged and the unit is plugged into an appropriate ac power source. When the unit is not plugged into an ac power source, the multimeter display should read approximately 25.5 Vdc.

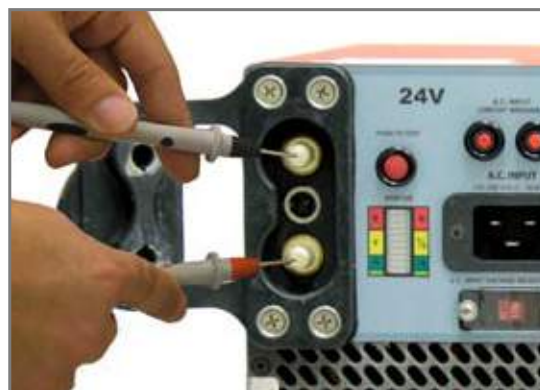

Figure 3.8.2 – Testing DC Receptacle

Check Unit Internal Resistance (Test for Shorts)



NOTE

Unit should be disconnected from any AC power sources prior to testing.

1. Testing between the Chassis Ground and the 12 Vdc Output Connector.

Set multimeter to Volts. Place the black lead of the multimeter on one of 12 Vdc Output Connector screws as shown in Figures 3.8.3 and 3.8.4. Next, touch the red lead of the multimeter to the positive pin of the 12 Vdc Output Connector (shown in Figure 3.8.3). Do the same for the negative pin (see Figure 3.8.4). In both cases the meter should read open circuit.



3.8.3 - DC Output Connector Positive Pin



3.8.4 - DC Output Connector Negative Pin

2. Testing between the Chassis Ground and the 24 Vdc Output Connector.

Set multimeter to Volts. Place the black lead of the multimeter on one of 24 Vdc Output Connector screws as shown in Figures 3.8.5 and 3.8.6. Next, touch the red lead of the multimeter to the positive pin of the 24 Vdc Output Connector (shown in Figure 3.8.5). Do the same for the negative pin (see Figure 3.8.6). In both cases the meter should read open circuit.



3.8.5 - DC Output Connector Positive Pin



3.8.6 - DC Output Connector Negative Pin

3. Testing the NEMA Receptacle.

Set multimeter to Ohms. Place the black lead on the ac ground post and the red lead to the dc positive post (shown in Figure 3.8.7). Next, move the red lead of the multimeter to the dc negative post. In both cases the Multimeter should read greater than 10 MΩ.



3.8.7 - Negative Probe on the AC Ground Post and the Positive Probe on the DC Positive Post.



3.8.8 - Positive Probe to the Fastener Screw on the DC Receptacle.

Move the positive probe to the fastener screw on the dc receptacle (shown in Figure 3.8.8). Multimeter should read less than 1 Ω.

3.9 – Pre-Operation

1. Be sure to check that all input and output cables are not damaged. (See Section 5.1)
2. Check unit carefully for any evidence of damage.
3. Make sure that airflow is not obstructed from air intake and outlet. (See Section 2.6)
4. Check that all connections are secure and free from water.



Figure 3.9.1 - TI2560 12-24 GPU

3.10 – Transporting Unit

The TI2560 12-24 GPU has a telescoping handle that makes rolling the unit easy. For transporting on uneven ground, axle extensions should be added to the unit. For use on sand, balloon tires should be installed on the unit (see Optional Accessories).



Figure 3.10.1 Releasing Telescopic Handle

3.11 – Regulated 14.25 / 28.5 Vdc Ground Power

Connecting DC Power Cable To Unit

Line up the DC plug with the receptacle. Push forward while rotating the T-handle one full turn clockwise. Ensure DC power cable plug is fully seated into the GPU's DC Battery Receptacle. The unit is now ready to safely transfer power.



Figure 3.11.1 Attaching DC Power Cable to GPU

Connecting DC Power Cable To Vehicle or Aircraft

Line up the NATO plug or aviation dc plug pins and push it in. DC bus power should come on and aircraft voltmeter should indicate 24 Vdc to 23.5 Vdc (23 Vdc minimum). Ensure dc power cable plug is fully seated into the vehicle or aircraft's dc receptacle.



Figure 3.11.2 Attaching NATO DC Power Cable to vehicle



Figure 3.11.3 Attaching an Aviation DC Power Cable to aircraft

⚡ WARNING Do not allow alligator clamps to touch when connecting to dc Power.



Figure 3.11.4 - Connecting TI2560 12-24 GPU to AC Power Supply with DC Power Cable Attached

Low Power Demand

Low power demand is a requirement of less than 20 amps for the 12 Vdc output and 25 amps for the 24 Vdc output. While power demands remain under these current levels, converter outputs will remain at 14.25 Vdc and 28.5 Vdc and only one green LED on the Capacity Meters will illuminate.

High Power Demand

High power demand is a requirement of 20 amps or more for the 12 Vdc output and 25 amps for the 24 Vdc output. When current demands go above these levels, the converter output voltages will drop and two or more LED Capacity Meter bars will illuminate. At approximately 20 amps of current demand for the 12 Vdc output, the converter output voltage will be regulated to 12 Vdc. For the 24 Vdc output, approximately 40 amps of current will cause the converter to regulate the voltage to 24 Vdc. In both cases, the last red LED on the Capacity Meter will illuminate.



NOTE

When all LED status indicator bars illuminate, both the converter and power cells are supplying 24 Vdc power output for current demands above 25 amps (or 20 amps for 12 Vdc).

Engine Starting



CAUTION

Unplug ac power cord before starting engine with unit.

Prior to engine start, ensure power cell charge is sufficient to provide an efficient engine start. Check dc power cable for secure and correct installation prior to engine starting. Follow ground power engine starting procedure as specified in vehicle operator's manual.

Removing DC Power Supply From Vehicle

1. Remove dc power cable GPU connector from vehicle.
2. Remove dc power cable connector from TI2560 12-24 GPU (if necessary).
3. Reinstall dc Receptacle's Protective Cover.

3.12 – Regulated AC Power

Plugging in with AC Power

When the TI2560 12-24 GPU is plugged into ac power, the output is 28.5 volts. This voltage allows the system to recondition and recharge the vehicle's battery(ies). It is also an optimum voltage for powering avionics and lighting on most aircraft. The GPU's ac to dc converter produces continuous amps of dc power depending on the size of the system.



NOTE

Check Input Voltage Selector Switch for proper setting.



Figure 3.12.1 - Connecting TI2560 12-24 GPU to AC Power Supply



Figure 3.12.2 - AC Power Connected with LEDs Illuminated

Connect AC Power Cord To Unit

Ensure 120 or 240 Vac power cord is properly connected to an approved ac power supply. After approximately 5-8 seconds, unit's LED status indicator will illuminate indicating power cell state of charge. Cooling fan will operate. Ensure LED status indicator and cooling fan is operational prior to continuing.

3.13 – Charging Unit

Once you have the voltage selector switch set to match the power characteristics of your line cord, you can plug the unit into a wall socket to charge the batteries. Until the unit is fully charged, the LED status will read half or no charge. Plug the TI2560 12-24 GPU into ac power to keep the cells charged whenever it is not in use, even if it is at Full Charge. The unit will not overcharge or overheat.

If you received this manual with a new GPU.

When the Unit is fully charged the LED indicator should show a single steady green bar. The fan will also come on at reduced speed. This is normal operation indicating the unit is in standby mode and is ready for use.

If you own an older GPU and this is a replacement manual.

Under a full charge the LED indicator should show a single steady green bar or the entire LED will be blinking. The fan will also exhibit ratcheting but will not come on. This is normal operation indicating the unit is in standby mode and is ready for use.

If the GPU's cells need to be replaced.

After 60 minutes of AC power input, the unit should be fully charged. If the "Push to Test" button is pressed and the unit still indicates it is not fully charged then the cells should be replaced.

Section 4 – Post Operation

4.1 – General

Although the TI2560 12-24 GPU has been ruggedized and made weather resistant within the scope of unit's intended use, it is essential that good general care be taken to maintain unit in good operating condition and to maximize unit's operational life.

4.2 – After Use

Unit should be protected from environmental elements and man made hazards. Ideally unit should be secured in a building or shed. Most importantly, unit shall be fully covered if stored while exposed to environmental elements.

4.3 – Power Cell Recharge

 NOTE	The TI2560 12-24 GPU incorporates a backcharge feature that enables the unit to be recharged from the vehicle once the engine is started and the starter/generator is running. This feature will enable you to start multiple vehicles without reconnecting to ac power if the GPU is allowed to backcharge for approximately 30 seconds.
---	---

 NOTE	Plug the TI2560 12-24 GPU into ac power to keep the cells charged whenever it is not in use, even if it is at Full Charge. The unit will not overcharge or overheat.
---	--

Connect AC Power Cord to Unit

 NOTE	Check Input Voltage Selector Switch for proper setting.
---	---

Ensure 120 or 240 Vac power cord is properly connected to an approved ac power supply. After approximately 5-8 seconds, ensure unit's LED status indicator illuminates indicating power cell state of charge and cooling fan is operating.

Any time the unit's power cells are fully discharged the unit shall be recharged within 24 hours to prevent performance degradation and ensure maximum life.



Figure 4.3.1 Connecting TI2560 12-24 GPU to AC Power Supply



Figure 4.3.2 AC North American Line Cord

**CAUTION****Guard From Incorrect Power Source**

The TI2560 12-24 GPU's power cells may be damaged if recharged by NiCad or Lithium Ion battery chargers. Power cells should only be charged by either the TI2560 12-24 GPU's internal charger and the ac power cord furnished with the equipment, or when connected to aircraft's external dc power receptacle.



Figure 4.3.3 - Proper and Improper Charging Methods

Section 5 – Unit Care and Maintenance



WARNING

Severe injury or death from electrical shock may occur if either the user or the unit is wet while operating the unit with an ac power source attached.



CAUTION

Damage may occur if an unapproved or modified ac line cable or input plug is attached to the unit. Do not use any type of ac voltage converter.

5.1 - Unit Care

Avoid Prolonged Exposure to Extremely Damp Environments

Be sure to disconnect ac power from the ac source if the unit has come into contact with water. If the AC Input Circuit Breaker has tripped due to water infiltration, allow the unit to dry out before attempting to reset circuit breaker. Cover the unit to prevent water seepage. If the unit is operated in extremely damp conditions, it should be stored in an environmentally controlled building when not in use. Wipe unit clean periodically with a soft cloth to remove dust, dirt, etc.



Protect Cables from Damage

Do not cut, crush, or drag the input or output power cables when handling the unit. Always inspect cables prior to use. If no damage is evident, proceed to the next step. If damage is evident, contact Tesla™ Customer Service. Do not attempt to use any other type of power cables other than the Tesla™ cables included with the unit.



Figure 5.1.1 – Damaged cable

5.2– Unit Servicing

This unit is a maintenance-free, sealed unit. No repairs outside of Tesla™ are authorized. Warranty will be voided if unit is tampered with in any way including any damage to the WARRANTY VOID stickers located on the case (see Figure 5.2.1 below). If the unit requires maintenance, please contact Tesla™ Customer Service at (302) 324-8910. A Repair Request Form can be found in the back of this manual.



Figure 5.2.1 – Warranty Void stickers Front and Back on the unit

5.3 – Packaging and Shipping

When returning the GPU, please ensure that it is properly packaged. The only method for transport is in a sturdy shipping crate or Tesla™ Shipping Case (be sure to enclose the Repair Request Form). Seal the crate on all sides and return it to Tesla™ at the address listed below. Please contact Tesla™ Customer Service at (302) 324-8910 with any questions or concerns.

TESLA™ INDUSTRIES, INCORPORATED
101 CENTERPOINT BLVD.
CENTERPOINT INDUSTRIAL PARK
NEW CASTLE, DELAWARE 19720
PHONE: (302) 324-8910 FAX: (302) 324-8912
Website: www.teslaind.com
Email: Tesla1@teslaind.com



Figure 5.3.1 – Tesla™ Industries Shipping Case

5.4 – Storage

If unit can not be connected to ac power while in storage, we recommend to charge the unit once a year. The shelf-life of 12 months is due to the battery /cells inside the unit. We guarantee the unit will hold 80% of its charge for a period of 12 months without being recharged. When the GPU's leave the facility, they are fully charged and if they are to go into storage (without being used), they will maintain 80% of their charge after 12 months. The life expectancy of the units, if maintained properly, is 5 to 7 years.

Section 6 – Troubleshooting and FAQ

6.1 – Frequently Asked Questions

1. Why should I buy a Tesla™ Turbo Start™ System?

Tesla™ Turbo Start™ is a multi-functional system that are ideal for support of 24 Vdc vehicles and aircraft and their electronics/avionics on the bench. Tesla™ manufactures various systems of different sizes and capacities that are man-portable, maintenance free and provide pure, dc power in a completely safe package. Designed for Military applications, these systems are equally valuable in maintenance support at the main facility or in remote locations. They are easily transported and air-portable. They will also provide 28.5 Vdc when the system is connected to the appropriate ac source.

2. How does a Turbo Start™ work?

The Turbo Start™ combines state of the art power conversion electronics with our proprietary “dry cell” batteries. The system’s electronics incorporate an intelligent charging system for the cells. The cells are ideal for this application as they are non-spillable, absorbed electrolyte dry cells that are sealed, maintenance free and safe for air transport.

3. How is Turbo Start™ used in Aviation Support?

There are many ways a Turbo Start™ will benefit your operation. By using it for pre-flight testing, you will avoid depleting the aircraft’s battery. You can start the aircraft’s engine with the Turbo Start™ as well. In the hangar, when connected to ac power, the Turbo Start™ will provide 28.5 Vdc for avionics testing and will also recondition and recharge the aircraft’s battery. Another benefit is the ability to fly with the Turbo Start™ aboard your aircraft. You may take the Turbo Start™ anywhere you travel, ensuring that you will always have power.

4. How much power will my Turbo Start™ provide?

Depending on the system, the Turbo Start™ will provide anywhere from 1500 to 3500 peak starting amps, 25 to 400 continuous amps dc and 23 to 96 hours of rechargeable power. See our website (www.teslaind.com) to determine the proper Turbo Start™ for your needs.

5. Will a Tesla™ Turbo Start™ spool up a turbine engine?

Nothing will start a turbine engine faster or safer than the right Tesla™ Turbo Start™. Not only will it eliminate hot starts, but it will extend the life of your starter, your engine and your battery while reducing maintenance. The Turbo Start™ senses the impedance from the starter/generator. It then provides the exact power required throughout the start-up curve.

6. How many engine starts will my Turbo Start™ provide until it is depleted?

The Turbo Start™ back-charges, almost instantly, once the vehicle / aircraft is started and the generator is on line. This “power flywheel” feature enables the Turbo Start™ to recharge itself right from the vehicle it started in less than 30 seconds. You can go down the line in your motor pool and start every 24V vehicle, without limit!

7. How do you prolong the life of the Turbo Start’s cells?

All you need to do is plug the unit in to the appropriate ac power outlet the system requires. AC power will recharge the system and keep the cells healthy. Users who regularly plug the system in can expect to get 5-7 years from their cells before they need to be replaced. Tesla™ cells do not have a memory like cell phone batteries. There is no need to fully discharge them. The recharging system will not overcharge the unit or produce excess heat.

8. Is it waterproof?

Water-resistant but not waterproof (See Environmental Section).

9. Are Tesla™ GPUs used in shop maintenance and testing?

Tesla™ systems are gaining popularity throughout maintenance facilities, instructional facilities, laboratories, manufacturing plants, aircraft hangars and many other locations. The reason is due to the precise dc power, the small, portable and quiet nature of our systems and the maintenance free aspect of our GPU's. We can custom tailor ground power systems to fit your individual requirements.

10. Can one person transport it?

Turbo Start™ is designed to be handled by one person. The TI500 is our smallest GPU system to date and weighs 36 lbs. The TI1000 weighs 57 Lbs and can be carried or wheeled on a dolly. Larger units have wheels incorporated directly on the system with an extendable handle.

11. Is the Turbo Start™ in the government purchasing system?

Yes. Tesla™ Industries is an approved vendor/supplier – our cage code is OVWE2. Most Tesla™ products are class IX, have a National Stock Number (NSN) designation and can be acquired through the DLA (Defense Logistics Agency).

12. How long does this unit stay charged?

Unit should never be allowed to discharge fully. In-field use, it receives a dc back charge directly from a running engine. When not in use, unit should be plugged into ac power (outlet) all the time. Tesla™ systems will retain 80% of their capacity after one year of storage.

13. How do I get my Turbo Start™ serviced?

Contact Tesla™. We can be reached at (302) 324-8910. Ask for customer service. You can also email us at tesla1@teslaind.com. Once we receive the unit at our facility, we will examine it. Systems that are protected under warranty will be repaired at no charge. If the warranty has expired, you will receive a quote for necessary repairs prior to work being done. Our turnaround time is 48 hours once repairs are authorized.

14. Can I make my own repairs to unit?

During the warranty period, the unit can only be repaired by Tesla™ Industries for the warranty to remain in effect. Regardless, we strongly recommend allowing Tesla™ to repair any unit as we will analyze the complete system and re-calibrate it.

15. What type of maintenance does the Turbo Start™ require?

Although the systems are maintenance free, please keep units plugged in while not in use. This will greatly extend the life of the cells. Also, keep the vent areas clean and free of debris. Keep units in a well ventilated area while charging. Keep the unit in a protected environment when not in use (maintenance facility, shed, etc.).

16. What is included with my Turbo Start™?

Aviation customers will receive an eight (8') foot DC Aviation Cable Assembly (TI2007-208). Ground vehicle customers will receive a fifteen (15') foot DC NATO Cable Assembly (TI2007-315). All customers receive an ac line cord for their home country and a full two year warranty.

17. Are there any HAZMAT issues or disposability problems?

There are none. Tesla™ will reclaim all battery cells for disposability purposes. Contact Tesla™ if you have questions.

6.2 - Basic Usage/Operation Questions

1. What's the best position to place the unit for use vertical or horizontal?

Preferred position is horizontal for stability and airflow considerations. When charging, the preferred position is horizontal. The Turbo Start™ can be put in any position while it is being used as there is nothing to spill inside the system.

2. Does the unit have to be plugged in all the time?

No, but for maximum performance and cell longevity, keep the unit plugged in while not in use.

3. What happens if I don't keep it plugged in?

Unit will eventually lose its charge and cell life is shortened.

4. How do I check the status of the charge?

Press the "Push to Test" LED bar indicator on the unit's faceplate. A fully charged unit will have one green LED light showing.

5. Why is the cooling fan always running when I am plugged into ac power?

Constant cooling fan operation ensures proper and consistent ventilation of the unit.

6. Why does the cooling fan slow down?

Cooling fan rpm varies for better temperature regulation.

7. Why does my LED flicker when the unit is plugged in?

Older Turbo Starts™ indicated a full charge with a flickering LED readout. Newer models feature the illumination of one green bar on the LED readout when the unit is fully charged.

8. What do I do if a circuit breaker trips?

The AC Input Circuit Breaker is located above the AC Input Connector. When the circuit breaker has been tripped, either of the red buttons will pop out. In the event that the breaker trips:

1. Disconnect the ac and dc connectors. (Unplug ac line cord on military unit.)
2. Wait for a minimum of 60 seconds.
3. Reset breaker by pressing red button.
4. Reconnect ac and dc connections to the unit. (Plug in ac line cord on military unit.)

The unit should power up automatically. If the breaker continues to trip, return the unit to Tesla™ Industries for repair.

6.3 - Basic Unit Troubleshooting

Fault	Possible Cause	Remedy
1. Output Capacity LED does not come on when button is pushed.	<p>A. Units cells completely dead.</p>	<p>A. Plug the unit in to the appropriate ac power outlet and recharge.</p> <p>B. If LEDs still do not illuminate, Please contact Tesla™ Customer Service at (302) 324-8910.</p>
2. Unit has no output dc or ac input or both.	<p>A. Units cells completely dead.</p> <p>B. AC line cord is damaged or bad.</p> <p>C. DC line cord is damaged or bad.</p> <p>D. AC circuit breaker has been tripped.</p> <p>E. Cables loose or corroded.</p>	<p>A. Do a function check with digital meter, see section 3.8.</p> <p>B. Do continuity test.</p> <p>C. No continuity, check cables for cuts and replace if needed.</p> <p>D. Clean contacts of debris and make sure connections are tight.</p>
3. Unit will not charge from ac outlet.	<p>A. AC line cord is damaged or bad.</p> <p>B. Is ac line cord fully plugged into unit and wall outlet.</p> <p>C. AC circuit breaker has been tripped.</p> <p>D. No ac power at outlet.</p>	<p>A. Do a continuity test on the ac line cord</p> <p>B. Check if line cord is properly secured.</p> <p>C. Check to make sure ac circuit breaker is placed in the “ON” position.</p>
4. Unit failed function test.	<p>A. Internal failure.</p>	<p>A. Please contact Tesla™ Customer Service at (302) 324-8910.</p>
5. Unit emits sparks when plugged into power source.	<p>A. Water or moisture has seeped in unit</p> <p>B. Internal failure.</p>	<p>A. Move unit to dry warm air and allow to dry for over 48 hours.</p> <p>B. Do Not Use Unit. Please contact Tesla™ Customer Service at (302) 324-8910.</p>
6. Unit works then shuts down.	<p>A. Unit is overheating.</p> <p>B. Cooling fans and vents are obstructed or inoperable.</p>	<p>A. Move the unit to an area 10° -20° less ambient temperature.</p> <p>B. Clean and clear cooling vents, turn on unit and inspect if air is flowing through unit. If no airflow please contact Tesla™ Customer Service at (302) 324-8910.</p>

Fault	Possible Cause	Remedy
7. Circuit breaker continuously trips	A. Unit is overheating.	A. Disconnect unit from ac input and dc output. B. Switch breaker to ON position. C. Reconnect unit to cables and run. D. If LEDs still do not illuminate, Please contact Tesla™ Customer Service at (302) 324-8910.
8. Unit does not put out 28.5 volts dc power.	A. Unit is not plugged in.	A. Plug unit into ac power source to maintain 28.5. B. Stand alone Vdc is 24 Volts (unplugged).
9. Unit stand alone voltage is less than 23 volts.	A. Cells discharged.	A. Plug unit into ac power source. B. Recheck capacity after 25 minutes. C. Failure to hold above 23 Vdc, Please contact Tesla™ Customer Service at (302) 324-8910.
10. Unit weakens after first start.	A. Weak cells.	A. Allow between 30 to 60 seconds backcharge between uses.

Section 7 – Performance Data

7.1 – Purpose

This section provides performance data for the unit. Continual reference to this information will enable the user to obtain maximum performance, utilization and service life from the unit. Although maximum performance is not always required, regular referral to this section is recommended for the following reasons:

- A.** To generate knowledge of unit's performance margins to enable the operator to make sound judgment when unexpected conditions or alternate operational requirements are encountered.
- B.** To enable the user to readily recognize situations requiring maximum performance.
- C.** To gain experience in accurately estimating the effects of variables for which data is not presented.
- D.** To help the operator determine if a vehicle or an aircraft system malfunction exists by comparing actual performance with expected performance.



NOTE

The information provided in this section is primarily intended for operational planning and is most useful when planning operations under unfamiliar conditions or environmental extremes. The data may also be used to establish local operating procedures and to ensure unit's operational life is maximized.

7.2 – General

The data presented covers the maximum range of conditions and performance that can reasonably be expected. In each area of performance, the effects of temperature and dc electrical load demand relating to the ground power support requirements are presented. Wherever practical, data is presented conservatively. However, **NO GENERAL CONSERVATISM HAS BEEN APPLIED**. All performance data presented is within the applicable limits of the unit

7.3 – Data Basis

The type of data used is indicated at the bottom of each performance chart under DATA BASIS. The applicable report and date of the data are also given. The data provided generally are based on one of three categories:

- A.** Derived From Actual Controlled Testing: Controlled test data obtained on a similar unit type.
- B.** Calculated Data: Data based on tests, but not on a similar unit type placed under a controlled test.
- C.** Estimated Data: Data based on estimates using rules of physics, mathematics, and electrical engineering principles and concepts, but not verified by tests.

7.4 – Specific Conditions

The data presented are accurate only for specific conditions listed under the title of each chart or graph. Variables for which data are not presented, but which may affect that phase of performance, are discussed in associated text. Where data is available or reasonable estimates can be made the amount that each variable affect performance will be given.

7.5 – General Conditions

In addition to the specific conditions, the following general conditions are applicable to the performance data.

- A.** Variation in Aircraft: Power demand differences between individual aircraft of the same make and model are known to exist due to variations in dc electrical system efficiency. These differences, however, are considered insignificant and are not individually accounted for.
- B.** Ground Support and Aircraft Instrument Variations: The data shown in the performance charts do not account for instrument tolerance differences or inaccuracies.

7.6 – Temperature Conversion Chart

°C	°F	°C	°F	°C	°F	°C	°F
-60.0	-76.0	-27.0	-16.6	6.0	42.8	39.0	102.2
-59.0	-74.2	-26.0	-14.8	7.0	44.6	40.0	104.0
-58.0	-72.4	-25.0	-13.0	8.0	46.4	41.0	105.8
-57.0	-70.6	-24.0	-11.2	9.0	48.2	42.0	107.6
-56.0	-68.8	-23.0	-9.4	10.0	50.0	43.0	109.4
-55.0	-67.0	-22.0	-7.6	11.0	51.8	44.0	111.2
-54.0	-65.2	-21.0	-5.8	12.0	53.6	45.0	113.0
-53.0	-63.4	-20.0	-4.0	13.0	55.4	46.0	114.8
-52.0	-61.6	-19.0	-2.2	14.0	57.2	47.0	116.6
-51.0	-59.8	-18.0	-0.4	15.0	59.0	48.0	118.4
-50.0	-58.0	-17.0	1.4	16.0	60.8	49.0	120.2
-49.0	-56.2	-16.0	3.2	17.0	62.6	50.0	122.0
-48.0	-54.4	-15.0	5.0	18.0	64.4	51.0	123.8
-47.0	-52.6	-14.0	6.8	19.0	66.2	52.0	125.6
-46.0	-50.8	-13.0	8.6	20.0	68.0	53.0	127.4
-45.0	-49.0	-12.0	10.4	21.0	69.8	54.0	129.2
-44.0	-47.2	-11.0	12.2	22.0	71.6	55.0	131.0
-43.0	-45.4	-10.0	14.0	23.0	73.4	56.0	132.8
-42.0	-43.6	-9.0	15.8	24.0	75.2	57.0	134.6
-41.0	-41.8	-8.0	17.6	25.0	77.0	58.0	136.4
-40.0	-40.0	-7.0	19.4	26.0	78.8	59.0	138.2
-39.0	-38.2	-6.0	21.2	27.0	80.6	60.0	140.0
-38.0	-36.4	-5.0	23.0	28.0	82.4	61.0	141.8
-37.0	-34.6	-4.0	24.8	29.0	84.2	62.0	143.6
-36.0	-32.8	-3.0	26.6	30.0	86.0	63.0	145.4
-35.0	-31.0	-2.0	28.4	31.0	87.8	64.0	147.2
-34.0	-29.2	-1.0	30.2	32.0	89.6	65.0	149.0
-33.0	-27.4	0.0	32.0	33.0	91.4	66.0	150.8
-32.0	-25.6	1.0	33.8	34.0	93.2	67.0	152.6
-31.0	-23.8	2.0	35.6	35.0	95.0	68.0	154.4
-30.0	-22.0	3.0	37.4	36.0	96.8	69.0	156.2
-29.0	-20.2	4.0	39.2	37.0	98.6	70.0	158.0
-28.0	-18.4	5.0	41.0	38.0	100.4	71.0	159.8

Figure 7.1.1 – Temperature Conversion Chart

7.7 – Output Voltage

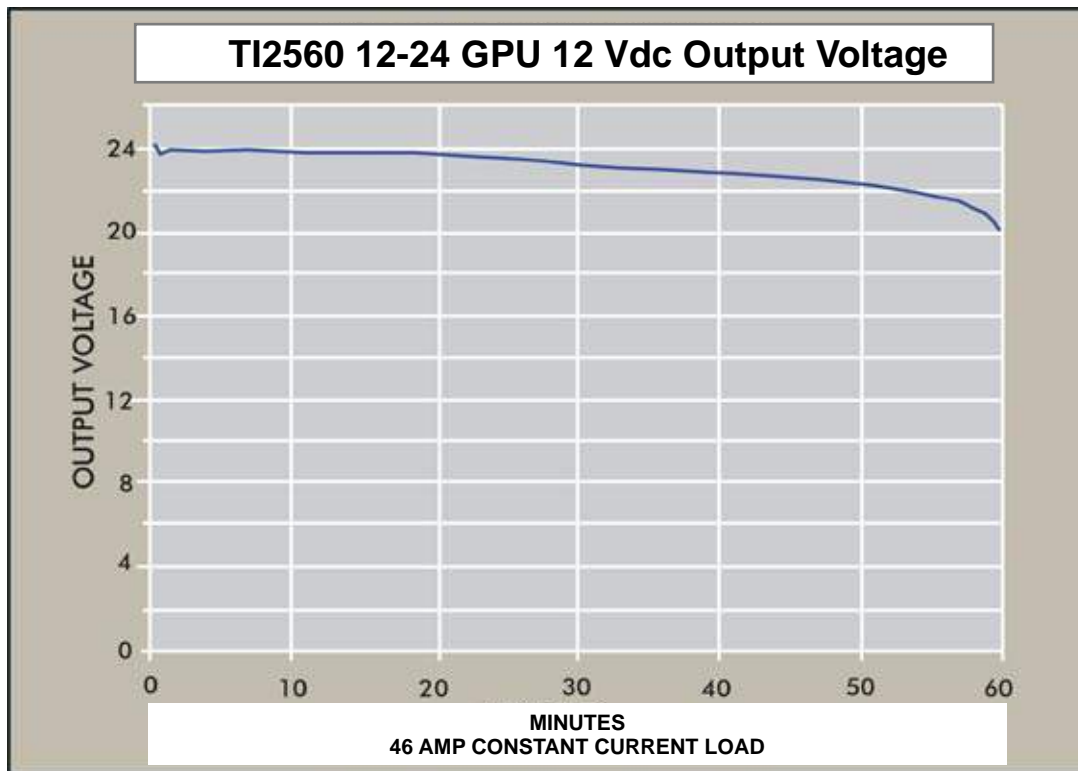

7.8 – Maximum Output Current

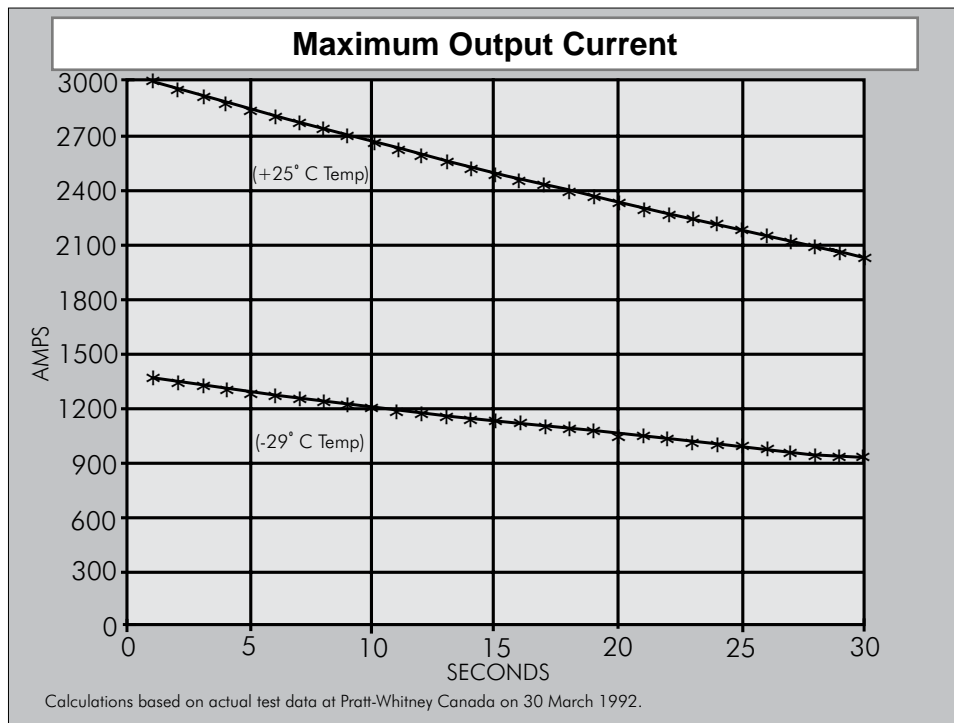

7.8 – 12 Vdc Output Loading Curves

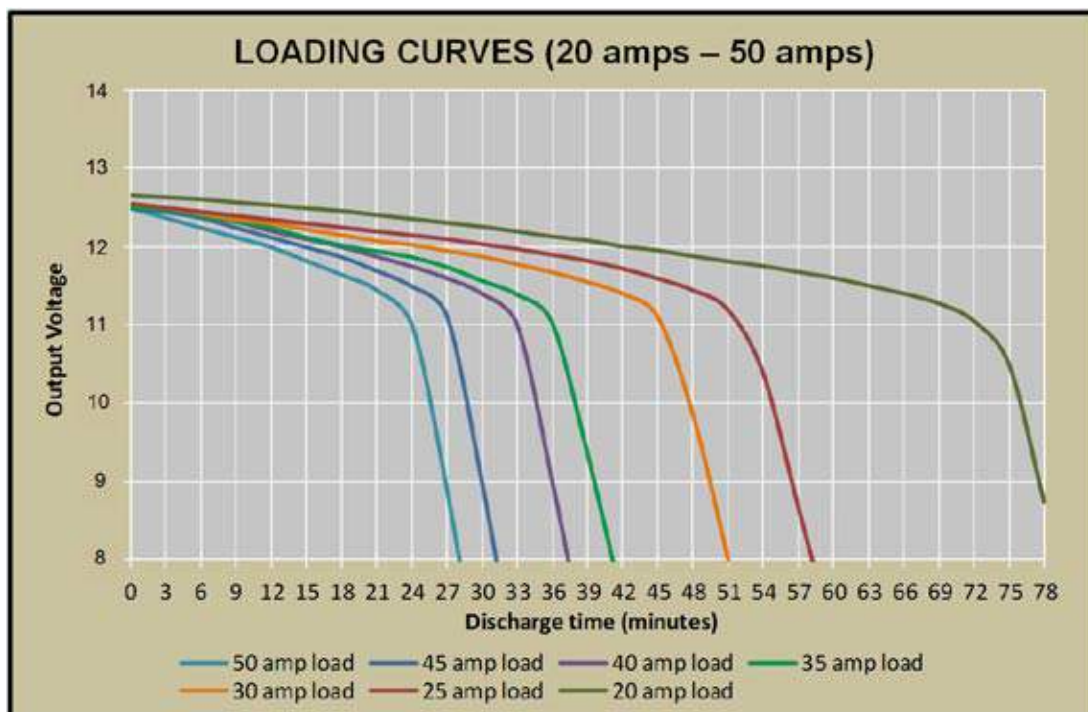
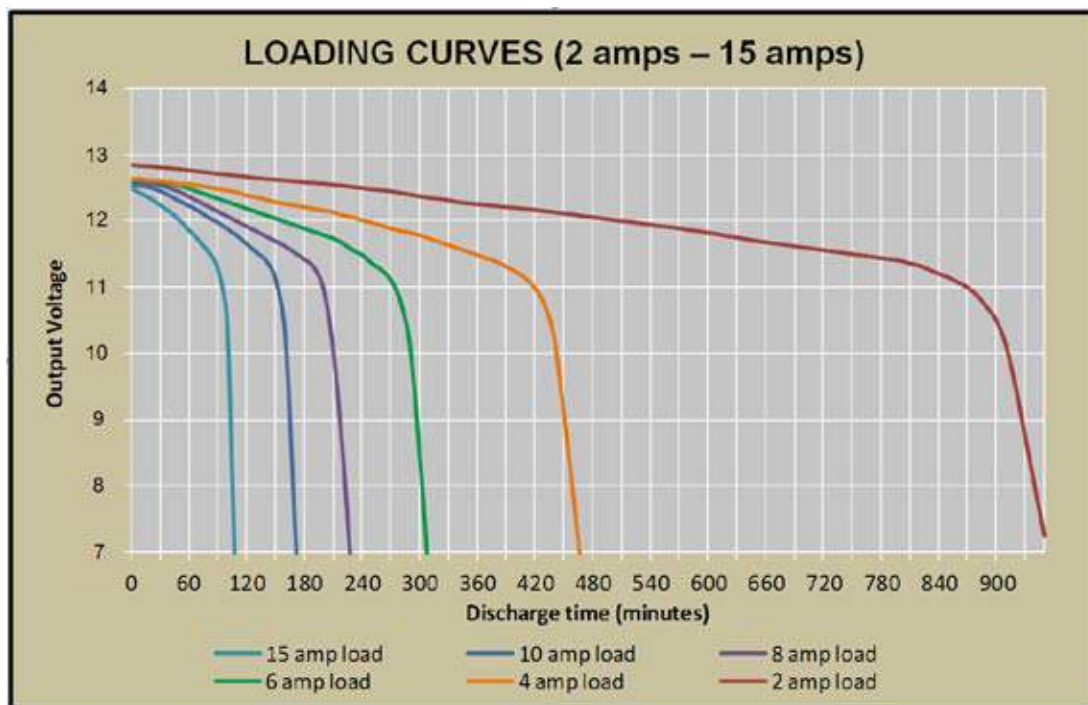

24 Vdc Output Loading Curves - cont'd

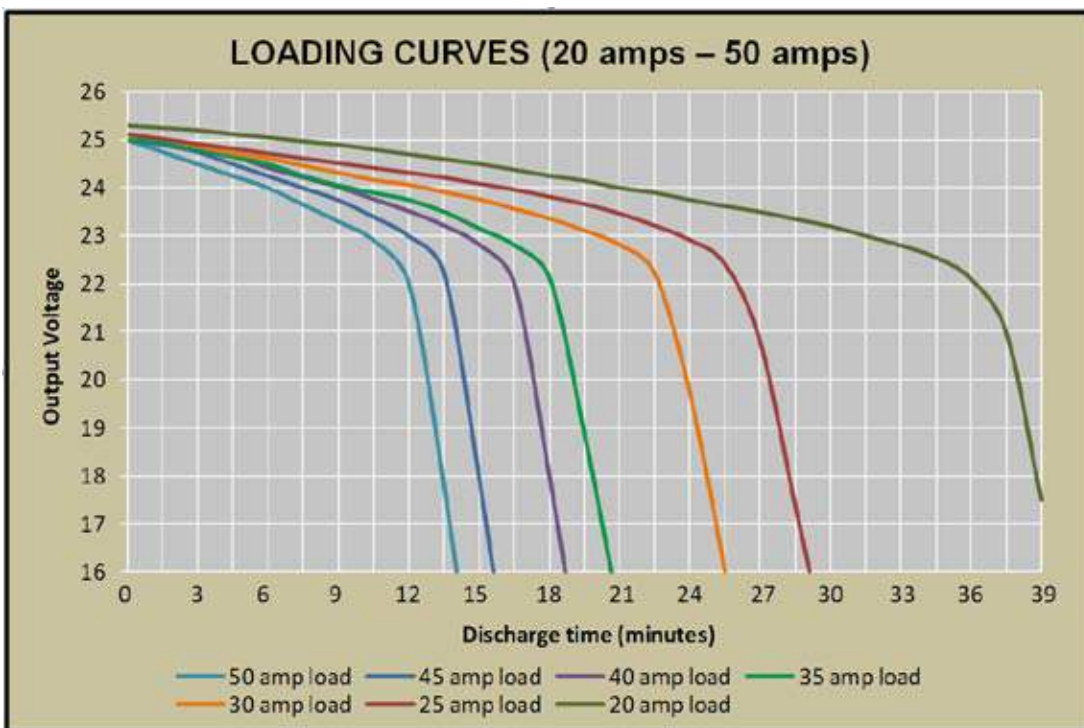
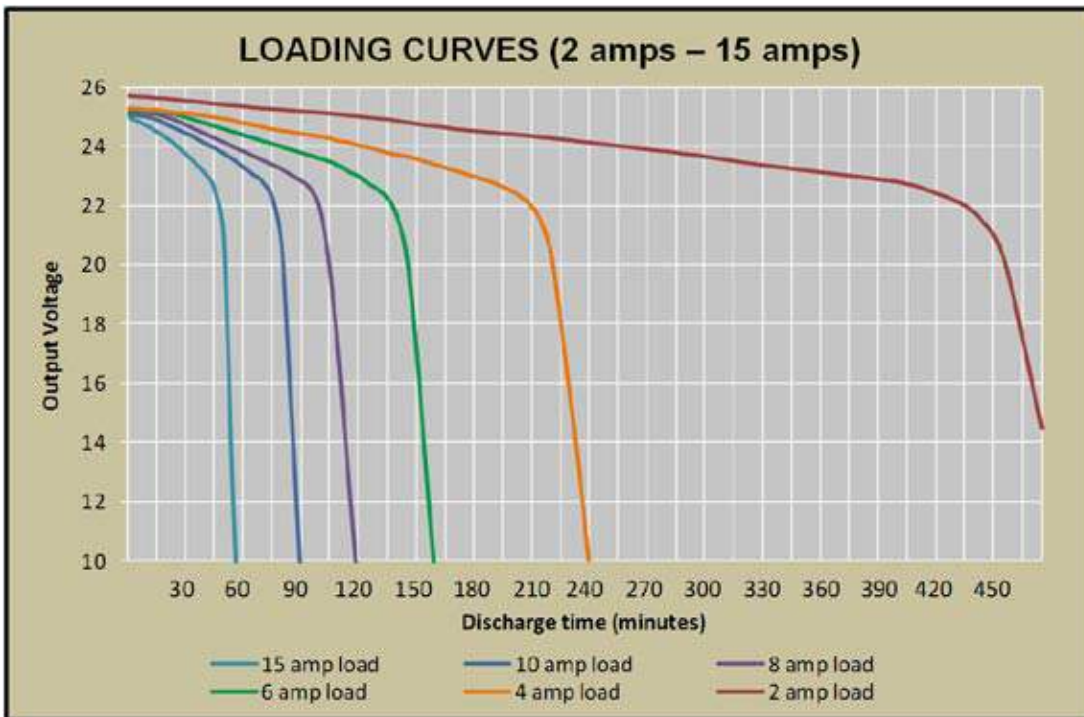

Section 8 – Optional Accessories

8.1 – Shipping Case

The optional Shipping Case is the safest way to transport the TI2560 12-24 GPU. This custom case weighs 73 lbs and comes equipped with side handles and locking latches.

TI7000-026

Length: 41.31" (1049.3 mm)
Width: 23.37" (593.60 mm)
Height: 19.62" (498.35 mm)
Weight: 73 lbs (33.11 kg)



8.2 – GPU Protective Covers

Protects unit from moisture, sand and other damaging elements. Custom fit for the TI2560 12-24 GPU.

TI7000-142



8.3 – Tesla™ AC Line Cords

These power cables come in several lengths or can be custom-ordered to fit your needs. Tesla™ specializes in outfitting cables with a variety of connectors and junction boxes. Contact Tesla™ Customer Service to find out more about our selection of cables.

Regular Line Cords

For units with a fuse and old-style receptacle.

TI25000-001 North American Line Cord
TI25000-002 Italian Line Cord
TI25000-003 Continental European Line Cord
TI25000-004 Old British Line Cord
TI25000-005 England / UK Line Cord
TI25000-006 Swiss Line Cord
TI25000-011 Australian Line Cord
TI25000-200 Israel Line Cord
TI25000-300 Denmark Line Cord

Line Cords

For units with a circuit breaker and new-style receptacle.

TI25000-211 North American Line Cord
TI25000-212 Italian Line Cord
TI25000-213 Continental European Line Cord
TI25000-214 Old British Line Cord
TI25000-215 England / UK Line Cord
TI25000-216 Swiss Line Cord
TI25000-201 Australian Line Cord
TI25000-203 Israel Line Cord
TI25000-304 Denmark Line Cord
TI25000-032 North American Commercial Line Cord

*To be used for TI3000 Commercial Unit only.



NEMA 515P



Italian



Continental European



Old British



England/UK



Swiss



Australian



Israel



Denmark



NEMA 520P

8.4 – Cobra™ DC Replacement Contacts and Tools

Cobra™ DC Plugs are designed to provide reliable high-power connections up to 3000 amps – even in the harshest conditions. Each plug is constructed from a rugged combination of advanced composite materials and corrosion-resistant alloys to maximize durability and connectivity. To extend the life of the Cobra™ Connector included with your unit, replacement contacts, posts, noses and tools can be ordered through the Tesla™ Customer Service.

TI2005-238

Cobra™ Aviation Plug



TI2005-078

Cobra™ NATO Connector

NSN: 6130-01-523-1270 (CL IX)



TI2005-251

DC Aviation Plug
Positive/Negative
Contact



TI2005-654

DC 400Hz Aviation Plug
Positive/Negative
Contact



TI2004-444

NATO Replacement Post

For newer NATO plugs with new style post, indicated by the black tip. Replacement plug uses standard 3/4" deep well socket for installation.



TI2005-250

DC Aviation Plug
3-slotted Connector



TI2005-239

Aviation Insertion/
Extraction Tool



TI2005-121

NATO Negative Contact

NSN: 5999-01-525-0582 (CL IX)



TI2005-117

NATO Positive Post

NSN: 5935-01-523-8914 (CL IX)



TI2004-341

Replacement Nose for
Aviation Plug



TI2004-340

Replacement Nose for
400Hz Aviation Plug



TI2005-126

NATO Negative Contact
Insertion/Extraction Tool

NSN: 5120-01-523-8761 (CL II)



TI27000-082

NATO Positive Contact
Insertion/Extraction Tool

NSN: 5120-01-527-7729 (CL II)



8.5 – GPU Tires

Tesla™ offers several tires in order to meet various customer mobility needs.



TI21000-203

Run-Flat Tire

A solid foam rubber tire. The standard tire for ground power units.



TI21000-400

Anti-FOD Flat-Free Tire

Rugged, puncture-proof, foam-filled tire. Foreign object damage free, specifically designed for the runway.



TI21000-192

Balloon Tire

For use on soft sand.

APPENDIX A

OPTIONAL LINE CORDS FOR WORLDWIDE OPERATIONS

<u>COUNTRY</u>	<u>VOLTS</u>	<u>HZ</u>	<u>TESLA™ PART #</u>
Afghanistan	220	50	TI25000-004 Old British Line Cord
Algeria	220	50	TI25000-004 Old British Line Cord
American Samoa	240	60	TI25000-011 Australian Line Cord
Angola	220	50	TI25000-003 Continental European Line Cord
Anguilla (U.K.)	240	50	TI25000-005 United Kingdom Line Cord
Antigua	230	60	TI25000-005 United Kingdom Line Cord
Argentina	220	50	TI25000-011 Australian Line Cord
Aruba	115	60	TI25000-001 North American Line Cord
Australia	240	50	TI25000-011 Australian Line Cord
Austria	220	50	TI25000-003 Continental European Line Cord
Azores (Portugal)	220	50	TI25000-004 Old British Line Cord
Bahamas	120	60	TI25000-001 North American Line Cord
Bahrain	220	50	TI25000-005 United Kingdom Line Cord
Bangladesh	220	50	TI25000-004 Old British Line Cord
Barbados	115	50	TI25000-001 North American Line Cord
Belgium	220	50	TI25000-003 Continental European Line Cord
Belize (Br. Hond.)	110	60	TI25000-001 North American Line Cord
Benin	220	50	TI25000-004 Old British Line Cord
Bermuda	120	60	TI25000-005 United Kingdom Line Cord
Bolivia	220	50	TI25000-003 Continental European Line Cord
Botswana	220	50	TI25000-005 United Kingdom Line Cord
Brazil	110	60	TI25000-001 North American Line Cord
Bulgaria	220	50	TI25000-003 Continental European Line Cord
Burkina Faso	220	50	TI25000-003 Continental European Line Cord
Burma (Now Myanmar)	230	50	TI25000-005 United Kingdom Line Cord
Burundi	220	50	TI25000-003 Continental European Line Cord
Cambodia	220	50	TI25000-003 Continental European Line Cord
Cameroon	230	50	TI25000-003 Continental European Line Cord
Canada	120	60	TI25000-001 North American Line Cord
Canary Islands (Spain)	220	50	TI25000-003 Continental European Line Cord
Cape Verde, Rep. of	220	50	TI25000-003 Continental European Line Cord
Cayman Islands	120	60	TI25000-001 North American Line Cord
Central African Republic	220	50	TI25000-003 Continental European Line Cord
Chad	220	50	TI25000-003 Continental European Line Cord
Channel Islands	240	50	TI25000-005 United Kingdom Line Cord
Chile	220	50	TI25000-002 Italian Line Cord
China, Peoples Republic of	220	50	TI25000-011 Australian Line Cord
Christmas Island (Australia)	240	50	TI25000-011 Australian Line Cord
Cocos Islands (Australia)	240	50	TI25000-011 Australian Line Cord
Columbia	220	60	TI25000-003 Continental European Line Cord
Congo, Republic of	220	50	TI25000-003 Continental European Line Cord
Cook Island (New Zealand)	240	50	TI25000-011 Australian Line Cord
Costa Rica	120	60	TI25000-001 North American Line Cord
Curacao Islands	110	60	TI25000-001 North American Line Cord
Cyprus	240	50	TI25000-005 United Kingdom Line Cord
Czech, Republic of	220	50	TI25000-003 Continental European Line Cord
Denmark	220	50	TI25000-300 Denmark Line Cord
Djibouti, Republic of	220	50	TI25000-003 Continental European Line Cord
Dominica	230	50	TI25000-005 United Kingdom Line Cord
Dominican Republic	110	60	TI25000-001 North American Line Cord

APPENDIX A (Cont.)

OPTIONAL LINE CORDS FOR WORLDWIDE OPERATIONS

<u>COUNTRY</u>	<u>VOLTS</u>	<u>HZ</u>	<u>TESLA™ PART #</u>
Ecuador	120	60	TI25000-001 North American Line Cord
Egypt	220	50	TI25000-003 Continental European Line Cord
El Salvador	115	60	TI25000-001 North American Line Cord
England	240	50	TI25000-005 United Kingdom Line Cord
Equatorial Guinea	220	50	TI25000-003 Continental European Line Cord
Estonia	220	50	TI25000-003 Continental European Line Cord
Ethiopia	220	50	TI25000-003 003 Continental European Line Cord
Fiji	240	50	TI25000-011 Australian Line Cord
Finland	220	50	TI25000-003 Continental European Line Cord
France	220	50	TI25000-003 Continental European Line Cord
French Guiana	220	50	TI25000-003 Continental European Line Cord
Gabon	220	50	TI25000-003 Continental European Line Cord
Gambia	220	50	TI25000-005 United Kingdom Line Cord
Georgia	220	50	TI25000-003 Continental European Line Cord
Germany	220	50	TI25000-003 Continental European Line Cord
Ghana	220	50	TI25000-005 United Kingdom Line Cord
Gibraltar	240	50	TI25000-005 United Kingdom Line Cord
Greece	220	50	TI25000-003 Continental European Line Cord
Greenland (Denmark)	220	50	TI25000-300 Denmark Line Cord
Grenada	230	50	TI25000-005 United Kingdom Line Cord
Guadeloupe	220	50	TI25000-003 Continental European Line Cord
Guam	110-120	60	TI25000-001 North American Line Cord
Guatemala	120	60	TI25000-001 North American Line Cord
Guinea	220	50	TI25000-003 Continental European Line Cord
Guinea-Bissau	220	50	TI25000-003 Continental European Line Cord
Guyana	110	50/60	TI25000-001 North American Line Cord
Haiti	110-120	50-60	TI25000-001 North American Line Cord
Honduras	110	60	TI25000-001 North American Line Cord
Hong Kong	220	50	TI25000-005 United Kingdom Line Cord
Hungary	220	50	TI25000-003 Continental European Line Cord
Iceland	220	50	TI25000-003 Continental European Line Cord
India	220-250	50	TI25000-004 Old British Line Cord
Indonesia	220	50	TI25000-003 Continental European Line Cord
Iran	220	50	TI25000-003 Continental European Line Cord
Iraq	220	50	TI25000-005 United Kingdom Line Cord
Ireland, Republic of	220	50	TI25000-005 United Kingdom Line Cord
Isle of Man	240	50	TI25000-005 United Kingdom Line Cord
Israel	230	50	TI25000-200 Israel Line Cord
Italy	220	50	TI25000-002 Italian Line Cord
Ivory Coast	220	50	TI25000-003 Continental European Line Cord
Jamaica	110	50	TI25000-001 North American Line Cord
Japan	110	50/60	TI25000-001 North American Line Cord
Jordan	220	50	TI25000-005 United Kingdom Line Cord
Kenya	240	50	TI25000-005 United Kingdom Line Cord
Korea, South	220	60	TI25000-003 Continental European Line Cord
Kuwait	240	50	TI25000-005 United Kingdom Line Cord

APPENDIX A (Cont.)

OPTIONAL LINE CORDS FOR WORLDWIDE OPERATIONS

<u>COUNTRY</u>	<u>VOLTS</u>	<u>HZ</u>	<u>TESLA™ PART #</u>
Laos	220	50	TI25000-001 North American Line Cord
Latvia	220	50	TI25000-003 Continental European Line Cord
Lebanon	220	50	TI25000-003 Continental European Line Cord
Lesotho	240	50	TI25000-004 Old British Line Cord
Liberia	120	60	TI25000-005 United Kingdom Line Cord
Liechtenstein	220	50	TI25000-006 Switzerland Line Cord
Lithuania	220	50	TI25000-003 Continental European Line Cord
Luxembourg	220	50	TI25000-003 Continental European Line Cord
Libya	230	50	TI25000-002 Italian Line Cord
Macao	220	50	TI25000-004 Old British Line Cord
Madagascar	220	50	TI25000-003 Continental European Line Cord
Maderia (Portugal)	220	50	TI25000-004 Old British Line Cord
Majorca	220	50	TI25000-003 Continental European Line Cord
Malawi	230	50	TI25000-005 United Kingdom Line Cord
Malaysia	240	50	TI25000-005 United Kingdom Line Cord
Maldives	230	50	TI25000-004 Old British Line Cord
Mali, Republic of	220	50	TI25000-003 Continental European Line Cord
Malta	240	50	TI25000-005 United Kingdom Line Cord
Martinique	220	50	TI25000-003 Continental European Line Cord
Mauritania	220	50	TI25000-003 Continental European Line Cord
Mauritius	230	50	TI25000-005 United Kingdom Line Cord
Mexico	127	60	TI25000-001 North American Line Cord
Monaco	220	50	TI25000-003 Continental European Line Cord
Mongolia	220	50	TI25000-003 Continental European Line Cord
Montseurrat	230	60	TI25000-005 United Kingdom Line Cord
Morocco	220	50	TI25000-003 Continental European Line Cord
Mozambique	220	50	TI25000-003 Continental European Line Cord
Namibia (W.S. Africa)	220-250	50	TI25000-004 Old British Line Cord
Nepal	220	50	TI25000-004 Old British Line Cord
Neth. Antilles	220	50/60	TI25000-003 Continental European Line Cord
Netherlands	220	50	TI25000-003 Continental European Line Cord
New Caledonia	220	50	TI25000-003 Continental European Line Cord
New Zealand	230	50	TI25000-011 Australian Line Cord
Nicaragua	120	60	TI25000-001 North American Line Cord
Niger	220	50	TI25000-003 Continental European Line Cord
Nigeria	230	50	TI25000-005 United Kingdom Line Cord
Norfolk Islands (Australia)	240	50	TI25000-011 Australian Line Cord
North Ireland	220	50	TI25000-005 United Kingdom Line Cord
North Mariana Islands (U.S.)	115	60	TI25000-001 North American Line Cord
Norway	220	50	TI25000-003 Continental European Line Cord
Okinawa	100-120	60	TI25000-001 North American Line Cord
Oman	240	50	TI25000-005 United Kingdom Line Cord
Pakistan	230	50	TI25000-004 Old British Line Cord
Panama	110	60	TI25000-001 North American Line Cord
Papua New Guinea	240	50	TI25000-011 Australian Line Cord
Paraguay	220	50	TI25000-003 Continental European Line Cord
Peru	110	50/60	TI25000-001 North American Line Cord
Philippines	115	60	TI25000-001 North American Line Cord
Piccairn Islands (U.K.)	240	50	TI25000-004 Old British Line Cord
Poland	220	50	TI25000-003 Continental European Line Cord
Portugal	220	50	TI25000-003 Continental European Line Cord
Puerto Rico	120	60	TI25000-001 North American Line Cord

APPENDIX A (Cont.)

OPTIONAL LINE CORDS FOR WORLDWIDE OPERATIONS

<u>COUNTRY</u>	<u>VOLTS</u>	<u>HZ</u>	<u>TESLA™ PART #</u>
Romania	220	50	TI25000-003 Continental European Line Cord
Russia	220	50	TI25000-003 Continental European Line Cord
Rwanda	220	50	TI25000-003 Continental European Line Cord
Saudi Arabia	220	50/60	TI25000-003 Continental European Line Cord
Scotland	220	50	TI25000-005 United Kingdom Line Cord
Senegal	220	50	TI25000-003 Continental European Line Cord
Seychelles	240	50	TI25000-005 United Kingdom Line Cord
Sierra Leone	230	50	TI25000-005 United Kingdom Line Cord
Singapore	230	50	TI25000-005 United Kingdom Line Cord
Slovakia	220	50	TI25000-003 Continental European Line Cord
Somalia	220	50	TI25000-003 Continental European Line Cord
South Africa	220-250	50	TI25000-004 Old British Line Cord
Spain	220	50	TI25000-003 Continental European Line Cord
Sri Lanka	230	50	TI25000-004 Old British Line Cord
St. Pierre & Miquelon (France)	115	60	TI25000-001 North American Line Cord
St. Kitts & Nevis	230	60	TI25000-005 United Kingdom Line Cord
St. Lucia	240	50	TI25000-005 United Kingdom Line Cord
St. Vincent	230	50	TI25000-005 United Kingdom Line Cord
Sudan	240	50	TI25000-005 United Kingdom Line Cord
Surinam	115	60	TI25000-003 Continental European Line Cord
Svalbard (Norway)	220	50	TI25000-003 Continental European Line Cord
Swaziland	230	50	TI25000-004 Old British Line Cord
Sweden	220	50	TI25000-003 Continental European Line Cord
Switzerland	220	50	TI25000-006 Switzerland Line Cord
Syria	220	50	TI25000-003 Continental European Line Cord
Tahiti	220	50	TI25000-003 Continental European Line Cord
Taiwan	110	60	TI25000-001 North American Line Cord
Tanzania	230	50	TI25000-005 United Kingdom Line Cord
Thailand	220	50	TI25000-003 Continental European Line Cord
Togo	220	50	TI25000-003 Continental European Line Cord
Tonga	115	60	TI25000-004 Old British Line Cord
Trinidad & Tobago	230	60	TI25000-005 United Kingdom Line Cord
Tunisia	220	50	TI25000-003 Continental European Line Cord
Turkey	220	50	TI25000-003 Continental European Line Cord
Uganda	220	50	TI25000-004 Old British Line Cord
United Arab Emir.	220	50	TI25000-005 United Kingdom Line Cord
United Kingdom & Ireland	240	50	TI25000-005 United Kingdom Line Cord
United States	120	60	TI25000-001 North American Line Cord
Uruguay	220	50	TI25000-011 Australian Line Cord
Venezuela	120	60	TI25000-001 North American Line Cord
Vietnam	220	50	TI25000-003 Continental European Line Cord
Virgin Islands	120	60	TI25000-001 North American Line Cord
Wales	220	50	TI25000-005 United Kingdom Line Cord
Western Samoa	230	50	TI25000-005 United Kingdom Line Cord
Yemen	220	50	TI25000-005 United Kingdom Line Cord
Yugoslavia	220	50	TI25000-003 Continental European Line Cord
Zaire, Republic of	220	50	TI25000-003 Continental European Line Cord
Zambia	220	50	TI25000-005 United Kingdom Line Cord
Zimbabwe	220	50	TI25000-005 United Kingdom Line Cord

APPENDIX A (Cont.)

UNIVERSAL LINE CORD KIT FOR WORLDWIDE OPERATIONS

NOTE: TESLA™ UNIVERSAL AC LINE CORD KIT, P/N: **TI25000-U00**, IS FOR UNITS ORIGINALLY BUILT WITH THE UNIVERSAL AC LINE CORD OPTION ONLY.
THE AC ADAPTER OPTION IS TESLA™ P/N **TI16000-19** AND MUST BE ORDERED WITH THE ORIGINAL PROCUREMENT OF UNIT(S). UNIT(S) MAY BE RETURNED TO TESLA™ INDUSTRIES, FOR A NOMINAL COST, AND MODIFIED TO ALLOW OPERATION WITH THE UNIVERSAL AC LINE CORD KIT.

TESLA™ UNIVERSAL AC LINE CORD KIT, P/N: **TI25000-U00**, IS COMPRISED OF THE FOLLOWING FIVE PART NUMBERS:

TI25000-111	NORTH AMERICAN LINE CORD
TI25000-113	EUROPEAN 10A/250V
TI25000-114	OLD BRITISH LINE CORD
TI25000-115	ENGLAND 10A/250V
TI7000-131	LINE CORD POUCH

Repair Request Form

Please complete the information below to ensure prompt and accurate service. Include this form with the unit you are returning. Thank you.

Date of return: _____

Company name & _____

Billing address: _____

Contact person: _____

Phone #: _____ Fax #: _____

Email: _____

Purchase Order #: _____

Model #: _____ Serial #: _____

Model #: _____ Serial #: _____

Shipping method to Tesla™: _____

Description of shipping package: _____

Description of problem: _____

Return to Tesla™ Industries, Inc.

101 Centerpoint Boulevard, New Castle, DE 19720 Attention: Repair Department



WE GET THE MILITARY STARTED!

Tesla™ Industries, Inc.

101 Centerpoint Blvd.
New Castle, DE 19720 USA
Tel: 302-324-8910
Fax: 302-324-8912

9475 Double R Blvd., Suite 2
Reno, NV 89521
Tel: 775-622-8801
Fax: 775-622-8810

www.teslaind.com

TI2560-12-24 GPU

The TI2560-12-24 GPU has been designed as a stand-alone source of dc power for ground support systems and maintenance operations. Using a single 120 Vac power source, it will provide both 12 Vdc and 24 Vdc continuous output power. In the field, it will produce up to 3000 peak amps — making the TI2560 a perfect solution for all of your ground power needs.

Features:

- 24 VDC Output:
- 3000 peak starting amps
 - 28.5 Vdc @ 25 amps continuous (connected to ac power)
 - 24.0 Vdc @ 46 amp hours of rechargeable power
- 12 VDC Output:
- 3000 peak starting amps
 - 14.25 Vdc @ 20 amps continuous (connected to ac power)
 - 12.0 Vdc @ 46 amp hours of rechargeable power
- Safe, easy, maintenance-free design
 - Non-hazardous, dry-cell technology
 - Dual Capacity Meter/Recharge State Indicators
 - Plugs into a standard ac power outlet to recharge cells
 - NEMA AC Line Cord
 - (24V side) 15' DC NATO Cable Assembly or 8' DC Aviation Cable Assembly
 - (12V side) 15' DC Cable with Alligator Clips



Power Anytime, Anywhere



Tesla™ Industries, Inc.

www.teslainsd.com

Email: tesla1@teslainsd.com

Headquarters: (302) 324-8910

101 Centerpoint Blvd. New Castle, DE 19720 USA

Western Regional Office: (775) 622-8801

9475 Double R Blvd. Suite 2, Reno, NV 89521 USA



The **POWER**
of
RED™



Dimensions and Technical Specifications

* All dimensions are in inches / millimeters

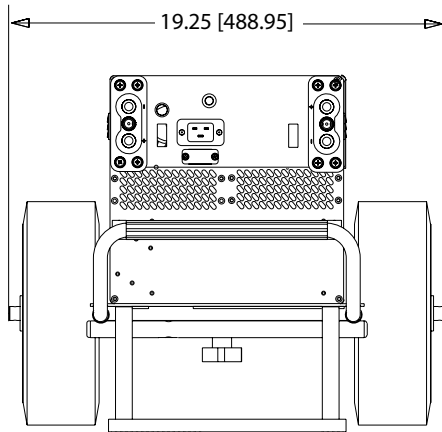

Front View

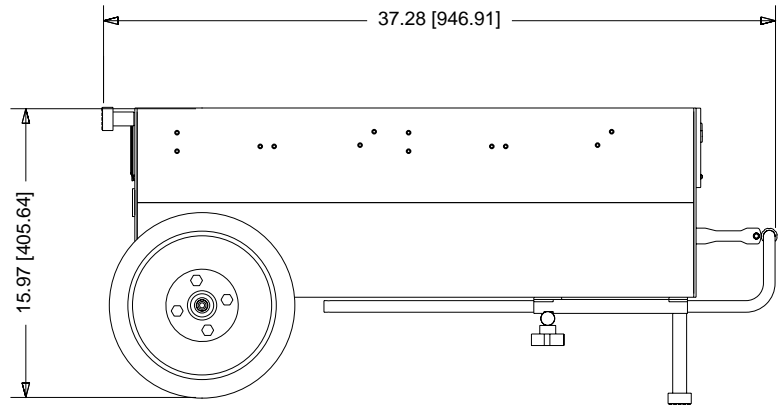

Side View

Technical Specifications:

Peak Starting Amps 24 Vdc Output: 12 Vdc Output:	3000 A 3000 A
Continuous Amps 24 Vdc Output: 12 Vdc Output:	28.5 Vdc @ 25 amps 14.25 Vdc @ 20 amps
DC Output - Rechargeable 24 Vdc Output: 12 Vdc Output:	24.0 Vdc @ 46 amp hrs. 12.0 Vdc @ 46 amp hrs.
Storage Temperature	-65° C to 105° C (-85° F to 221° F)
Operating Temperature w/o AC Power	-40° C to 60° C (-40° F to 140° F)
Operating Temperature w/ AC Power	-40° C to 55° C (-40° F to 131° F)
AC Input	100-260 Vac, 50/60 Hz, 14.7 amps max
Recharging Rate (from full discharge) 24 Vdc Output: 12 Vdc Output:	115 minutes w/ac power 143 minutes w/ac power
Weight	181.5 lbs (82.32 kg)
Warranty	2 years (3-year optional)

“Push to Test” Status Meter Indicators



Optional Accessories:



TI7000-142 Protective Cover



TI7000-026 Shipping Case