



Power Anytime, Anywhere

Tesla™ TIUH60 MPU-24

User Manual



Built Smart...Proven Tough

Tesla Industries, Inc.
101 Centerpoint Blvd.
New Castle, DE 19720
(302) 324-8910 Phone
(302) 324-8912 Fax
www.teslaind.com

NOTE: All users must read this entire manual prior to operating the TIUH60 MPU-24.

The TIUH60 MPU-24 is a limited maintenance-free and sealed unit. No repairs are authorized. Warranty will be voided if unit is tampered with in any way, or if unauthorized repairs are made. For technical support please contact:

TESLA™ INDUSTRIES INCORPORATED

101 CENTERPOINT BLVD.

CENTERPOINT INDUSTRIAL PARK

NEW CASTLE, DELAWARE 19720

PHONE: (302) 324-8910

FAX: (302) 324-8912

WEBSITE: www.teslaind.com

EMAIL: tesla1@teslaind.com



CAUTION

Shock Hazard Potential

Improper use or failure to follow instructions in this user manual can result in unit damage and/or injury or death by electrical shock.

Any attempts to open or examine the inside of the TIUH60 MPU-24 via a tool or device (borescope, probe, etc.) can result in unit failure and/or injury by electrical shock. This MPU is maintenance free and should not be opened or disassembled for any reason.

Always protect the unit from short circuit.

Shipping Hazards: The TIUH60 MPU-24 contains sealed, dry cell rechargeable batteries that do not pose a shipping hazard.

No part of this manual may be reproduced or transmitted in any form or by any means, electronic or mechanical, including photocopying, recording, or any information storage and retrieval system, without prior written permission from Tesla™ Industries, Inc.

Copyright © 2014 by Tesla™ Industries, Incorporated. All rights reserved.



INFORMATION ONLY - PLEASE READ SECTION X

SECTION I - PRODUCT AND MANUFACTURER IDENTITY

Product Identity:

Tesla[®]™ Turbo Start[®]™ Ground Power Unit (GPU) and Micro Power Unit (MPU) Containing Dry Cell (Starved Electrolyte) Batteries Used on Aviation/Military Application

Manufacturer's Name and Address:

Tesla Industries Inc.
101 Centerpoint Blvd.
New Castle, Delaware 19720

Emergency Telephone Number:

(302)324-8910
Fax: (302)324-8912
www.Teslainsd.com

SECTION II - INGREDIENTS

Hazardous Components	CAS #	OSHA PEL-TWA	% (By weight)
Lead	7439-92-1	50 µg/m ³	45 - 60 %
Lead Dioxide	1309-60-0	50 µg/m ³	15 - 25%
Sulfuric Acid Electrolyte	7664-93-9	1.0 mg/m ³	15 - 20%
Non-Hazardous Materials	N/A	N/A	5 - 10%

SECTION III - PHYSICAL/CHEMICAL CHARACTERISTICS

Boiling Point - N/A

Specific Gravity (H₂O=1) - NA

Vapor Pressure (mm Hg.) - N/A

Melting Point - N/A

Solubility in Water - N/A

Appearance & Color - N/A

SECTION IV - FIRE & EXPLOSION HAZARD DATA

Flash Point (Method Used): N/A

Flammable Limits: N/A

LEL: N/A

UEL: N/A

Extinguishing Media: Multipurpose Dry chemical CO₂ or water spray.

Special Fire Fighting Procedures: Cool GPU/MPU exterior to prevent rupture. Acid mists and vapors in a fire are toxic and corrosive.

Unusual Fire and Explosion Hazards: Hydrogen gas may be produced and may explode if ignited. Remove all sources of ignition.

SECTION V - REACTIVITY DATA AND SHIPPING/HANDLING ELECTRICAL SAFETY

Stability: Stable

Conditions to Avoid: Avoid shorting, high levels of short circuit current can be developed across the battery terminals. Do not rest tools or cables on the battery. Avoid over-charging. Use only approved charging methods. Do not charge in gas tight containers.

SECTION VI - HEALTH HAZARD DATA

Routes of Entry: N/A

Health Hazards (Acute & Chronic): N/A

Emergency & First Aid Procedures:

Battery contains acid electrolyte, which is absorbed in the separator material. If battery case is punctured, completely flush any released material from skin or eyes with water.

Proposition 65:

Warning: Battery posts, terminals and related accessories contain lead and lead compounds, chemicals known to the State of California to cause cancer and reproductive harm. Batteries also contain other chemical known to the State of California to cause cancer. Wash hands after handling

SECTION VII - PRECAUTIONS FOR SAFE HANDLING & USE

Steps to be taken in case material is released or spilled

Avoid contact with acid materials. Use soda ash or lime to neutralize. Flush with water.

Waste Disposal Method

Dispose of in accordance with Federal, State, & Local Regulations. Do not incinerate. Batteries should be shipped to a reclamation facility for recovery of the metal and plastic components as the proper method of waste management. Contact distributor for appropriate product return procedures.

SECTION VIII - CONTROL MEASURES - NOT APPLICABLE

SECTION IX - OTHER REGULATORY INFORMATION

Tesla™ Industries GPU/MPU batteries are sealed electrolyte batteries, which means the electrolyte is absorbed in the separator material. The batteries are also sealed.

NFPA Hazard Rating for Sulfuric Acid:

Health (Blue) = 3

Flammability (Red) = 0

Reactivity (Yellow) = 2

Sulfuric Acid is Water Reactive if concentrated.

U.S. DOT: Tesla™ Industries GPU/MPU batteries are classified as Nonspillable. They have been tested and meet the nonspillable criteria listed in 49 CFR § 173.159(f) and 173.159a(d)(1).

Nonspillable batteries are excepted from 49 CFR Subchapter C requirements, provided that the following criteria are met:

1. The batteries must be securely packed in strong outer packagings and meet the requirements of 49 CFR § 173.159a.
2. The batteries' terminals must be protected against short circuit.
3. Each battery and their out packaging must be plainly and durably marked "NONSPILLABLE" or "NONSPILLABLE BATTERY".

The exception from 49 CFR, Subchapter C means shipping papers need not show proper shipping name, hazard class, UN number and packing group. Hazardous labels are not required when transporting a nonspillable battery.

IATA: Tesla™ Industries GPU/MPU batteries have been tested and meet the nonspillable criteria listed in IATA Packing Instruction 872 and Special Provision A67. Nonspillable batteries must be packed according to IATA Packing Instructions 872. This means shipping papers need not show proper shipping name, hazard class, UN number and packing group. Hazardous labels are not required when transporting a nonspillable battery.

These batteries are excepted from all IATA regulations provided that the batteries are packed in a suitable out packaging and their terminals are protected against short circuits.

IMDG: Tesla™ Industries GPU/MPU batteries have been tested and meet the nonspillable criteria listed in Special Provision 238. Non-spillable batteries must be packed according to IMDG Packing Instruction P003. This means shipping papers need not show proper shipping name, hazard class, UN number and packing group. Hazardous labels are not required when transporting a nonspillable battery. These batteries are excepted from all IMDG codes provided that the batteries are packed in a suitable out packaging and their terminals are protected against short circuits per PP16.

RCRA: Spent lead-acid batteries are not regulated as hazardous waste by the EPA when recycled, however state and international regulations may vary.

CERCLA (Superfund) and EPCRA:

- (a) Reportable Quantity (RQ) for spilled 100% sulfuric acid under CERCLA (Superfund) and EPCRA (Emergency Planning Community Right to Know Act) is 1,000 lbs. State and local reportable quantities for spilled sulfuric acid may vary.
- (b) Sulfuric acid is a listed "Extremely Hazardous Substance" under EPCRA, with a Threshold Planning Quantity (TPQ) of 1,000 lbs.
- (c) EPCRA Section 302 notification is required if 1,000 lbs. or more of sulfuric acid is present at one site.
- (d) EPCRA Section 312 Tier 2 reporting is required for batteries if sulfuric acid is present in quantities of 500 lbs. or more and/or if lead is present in quantities of 10,000 lbs. or more.
- (e) Supplier Notification: this product contains toxic chemicals, which may be reportable under EPCRA Section 313 Toxic Chemical Release inventory (Form R) requirements.

If you are a manufacturing facility under SIC codes 20 through 39, the following information is provided to enable you to complete the required reports:

<u>Toxic Chemicals</u>	<u>CAS Number</u>	<u>Approximate % by Wt.</u>
Lead	7439-92-1	45-60
Sulfuric Acid	7664-93-9	15-20

SECTION X - ADDITIONAL INFORMATION

The Tesla™ Industries GPU/MPU sealed lead acid battery is determined to be an "article" according to the OSHA Hazard Communication Standard and is thereby excluded from any requirements of the standard. The Material Safety Data Sheet is therefore supplied for informational purposes only.

The information and recommendations contained herein have been compiled from sources believed to be reliable and represent current opinion on the subject. No warranty, guarantee, or representation is made by Tesla™ Industries, as to the absolute correctness or sufficiency of any representation contained herein and Tesla™ Industries assumes no responsibility in connection therewith, nor can it be assumed that all acceptable safety measures are contained herein, or that additional measures may not be required under particular or exceptional conditions or circumstances.

*N/A or Not Applicable - Not applicable for finished product used in normal conditions.

Table of Contents

Section 1 – Safety Review	1
1.1 – Safety Notices	1
1.2 – Symbols	1
1.3 – Hazards	2
1.4 – Important Safety Precautions	2
1.5 – Extreme Environments	2
Section 2 – Product Overview	3
2.1 – Introduction	3
2.2 – Indication of Terms: Shall, Should, and May	3
2.3 – General Specifications	4
2.4 – Physical Dimensions	5
2.5 – Airflow Ports	6
2.6 – Operating Position	6
2.7 – “Push to Test” Button and LED Status Indicator	7
2.8 – Maintenance Check	8
2.9 – Pre-Installation Procedures	8
2.10 – Installation	8
Section 3 – Operating Procedures	9
3.1 – Operating Procedures	9
3.2 – General	9
3.3 – Operating Limits and Restrictions	9
3.4 – Performance	9
3.5 – Engine Starting Power	10
3.6 – Temperature Specifications	11
3.7 – Environmental	12
3.8 – Normal Functional Test Procedures	13-14
3.9 – Regulated 28.5 Vdc Ground Power	15
3.10 – Regulated AC Power	15-16
3.11 – Charging Unit	17

Section 4 – Post Operation	18
4.1 – General	18
4.2 – After Use	18
4.3 – Power Cell Recharge	18-19
Section 5 – Unit Care and Maintenance	20
5.1 – Unit Care	20
5.2 – Unit Servicing	21
5.3 – Packaging and Shipping	21
Section 6 – Frequently Asked Questions	22-24
Section 7 – Optional Accessories	25
7.1 – Tesla™ AC Line Cords	25
Appendix A	26-30
Repair Request Form	31

Abbreviations and Symbols

Abbreviations that may be used within the text, headings and titles of this manual.

LIST OF ABBREVIATIONS



Abbreviation **Definition**

ac	Alternating Current
AFT	Airflow Technology
AWG	American Wire Gauge
amp or A	Ampere
cont	Continuous
°C	Degree Celsius
°F	Degree Fahrenheit
dc	Direct Current
EFF	Efficiency
ft	Feet
FWD	Forward
GPU	Ground Power Unit
Hr	Hour
Hz	Hertz
kg	Kilograms
kHz	Kilohertz
kW	Kilowatts
LED	Light Emitting Diode
max	Maximum
MΩ	megaohm
min	Minimum
MPU	Micro Power Unit
NEMA	National Electrical Manufacturers Association
Ω	ohm
PF	power factor
PFC	power factor correction
rms	root-mean-square
THD	Total Harmonic Distortion
TMDE	Test, Measurement, & Diagnostic Equipment
UAV	Unmanned aerial vehicle
Vac	Volts, Alternating Current
Vdc	Volts, Direct Current
W	watts

Section 1 – Safety Review

1.1 - Safety Notices

Safety notices appear throughout this manual to alert the user to important information regarding proper installation, operation, maintenance and storage of the unit. These notices, as illustrated below, contain a key word that indicates the level of hazard and a triangular icon that indicates the specific type of hazard.

 WARNING	Indicates a condition, operating procedure or practice, which if not adhered to could result in serious injury or death.
 CAUTION	Indicates a condition or operating procedure, which if not strictly adhered to could result in damage or destruction of equipment.
 NOTE	Indicates a condition, operating procedure or practice, which is essential to highlight.

1.2 - Symbols

The following symbols will appear within the warning triangles to alert the user to the specific type of danger or hazard.



General Warning

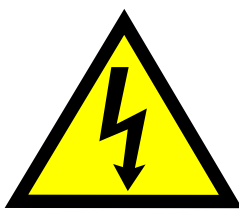

Electrical Hazard



Explosion Hazard



Fire Hazard



Battery Warning



Guard from Moisture

Figure 1.2.1 – Different types of hazard and caution symbols

1.3 – Hazards

 **WARNING** Shock Hazard Potential

Severe injury or death from electrical shock may occur if either the user or the unit is wet while the operating unit is connected to a power source. Be sure to disconnect ac power from the ac source if the unit has come into contact with water. If AC Input Circuit Breaker has tripped due to water infiltration, DO NOT try to reset it with the ac line voltage attached.



 **WARNING** Shock Hazard Potential

Severe injury or death from electrical shock can occur when damp electrical plugs are connected to the unit. Make sure the unit is turned off before making any connections. Failure to use proper grounding can cause potential shock hazard! In different countries, the power cord may require the use of a plug adapter to achieve plug style compatibility for operation. Use only adapters with proper grounding mechanism.

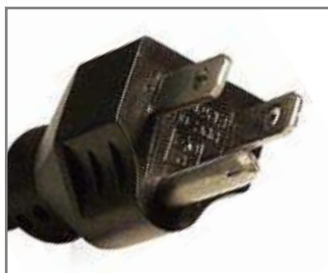

Figure 1.3.1 – Proper Ground Grounded Plug with Grounding Pin



Figure 1.3.2 – Proper Ground Adapter with Grounding Mechanism (Secured to Outlet)



Figure 1.3.3 – Improper Ground Plug with No Grounding Pin

 **CAUTION** Unit Damage Potential

The unit is equipped with a charger temperature switch that automatically disables the unit when the internal temperature exceeds 150°F (65°C). This protects the unit from overheating and damage. If the unit shuts down, move the unit into a cooler environment such as shade or air conditioning when possible. Perform a full function test after the unit has been allowed to cool prior to use.

1.4 – Important Safety Precautions

 **WARNING** Fire/Explosion Hazard Potential

Severe injury or death from fire or explosion can occur if electrical sparks are produced near fuel vapors. DO NOT CONNECT 120 or 240 Vac Power Supply WHILE FUELING. Do not charge the MPU using a 120-240 Vac Power during any fuel handling operation. Power output is restricted to 24 Vdc power only.

Section 2 – Product Overview

2.1 – Introduction

Thank you and congratulations on the purchase of your new TIUH60 MPU-24.

This manual contains the complete operating instructions and procedures for the TI60 Micro Power Unit. The TIUH60 MPU-24 is intended to provide dc electrical ground power for aircraft flight line and maintenance ground support operations. The unit is designed to provide 24 volt dc electrical power output for aircraft engine starting and 24 or 28.5 volts dc electrical support for ground maintenance, avionics/electrical trouble shooting and testing. The observance of procedures, limitations and performance criteria is essential to ensure peak operating efficiency and to maximize operational capabilities and life of the TI60 Micro Power Unit.

The TI60's high capacity power cells and circuitry are encased in a rugged enclosure, and are designed to replace the original battery for the M134 Dillon Minigun. The internal circuitry incorporates an intelligent recharging system that allows the MPU to recharge from either the aircraft generator or from a standard 110 Vac or 220 Vac power source. The unit is also equipped with a built-in capacity meter that also serves as a recharge state indicator.



Figure 1.1.1 – TIUH60 MPU-24

2.2 – Indication of Terms: Shall, Should and May

Within this technical manual the word “shall” is used to indicate a mandatory requirement for proper operation and warranty purposes. The word “should” is used to indicate a non-mandatory but preferred method of accomplishment. The word “may” is used to indicate an acceptable method of accomplishment.

2.3 – General Specifications

Electrical

AC Input Power:

- Operates and charges from single phase 100-260 Vac 50/60 Hz
- 5.5 amps @ single phase 120 Vac 60 Hz
- 2.75 amps @ single phase 240 Vac 60 Hz

DC Output Power:

- 750 peak starting amps
- 10 amps continuous @ 28.5 Vdc (when plugged into ac power)
- 21.5 amp hours (541 watt hours) with ac power
- 11.5 amp hours (256 watt hours) of rechargeable battery power without ac

Recharge Rate From Full Discharge:

- 74 minutes @ 25 °C

Size:

- 8.45" L x 9.88" W x 7.57" H
- 214.7 mm x 250.8 mm x 192.2 mm

Weight:

- 27 lbs (12.25 kg)

Operating Temperature:

- -40 °C to +60 °C (-40 °F to 140 °F) without ac power
- -40 °C to +55 °C (-40 °F to 131 °F) with ac power

Storage Temperature:

- -65 °C to +105 °C (-85 °F to 221 °F)

Cell Capacity:

- +40 °C 110% ± 05%
- +25 °C 100% ± 05%
- +00 °C 80% ± 05%
- -20 °C 65% ± 10%
- -40 °C 50% ± 10%

2.4 - Physical Dimensions

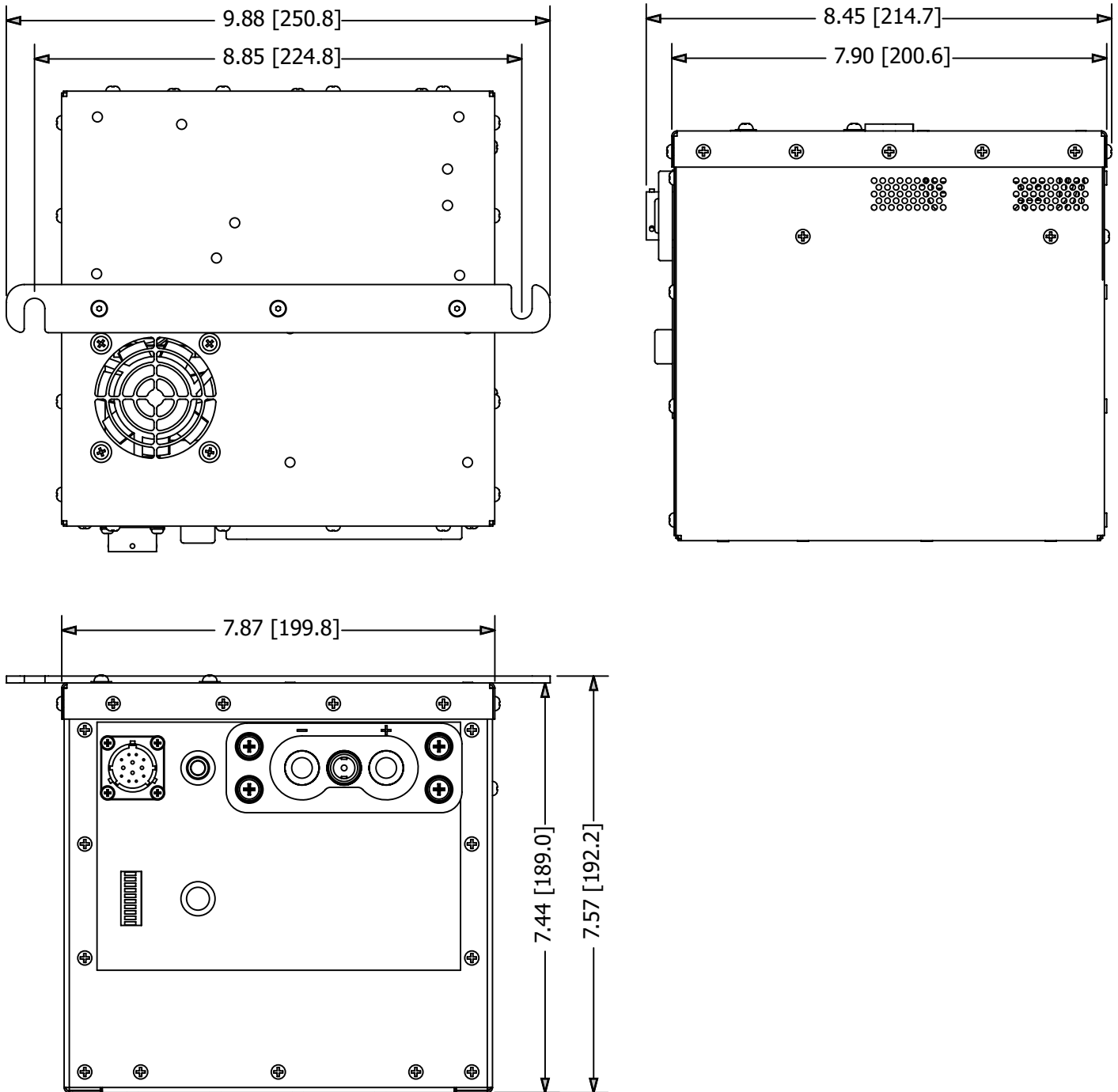

Figure 2.4.1 - TIUH60 MPU-24 physical dimensions

2.5 – Airflow Ports

CAUTION

Damage may occur if the TIUH60 MPU-24's air intake or outlet ports are obstructed. Ensure that ports are clear at all times.

The internal cooling system of the TIUH60 MPU-24 has been designed to efficiently regulate unit temperature regardless of load. At room temperature (+77°F) the exhaust air will not exceed the ambient temperature by more than 5°. In more extreme temperatures (greater than 90°F), the exhaust air will not exceed the ambient temperature by more than 10°.

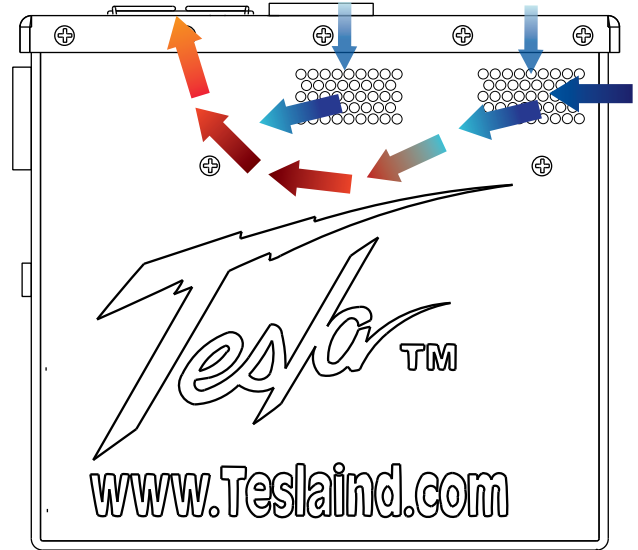
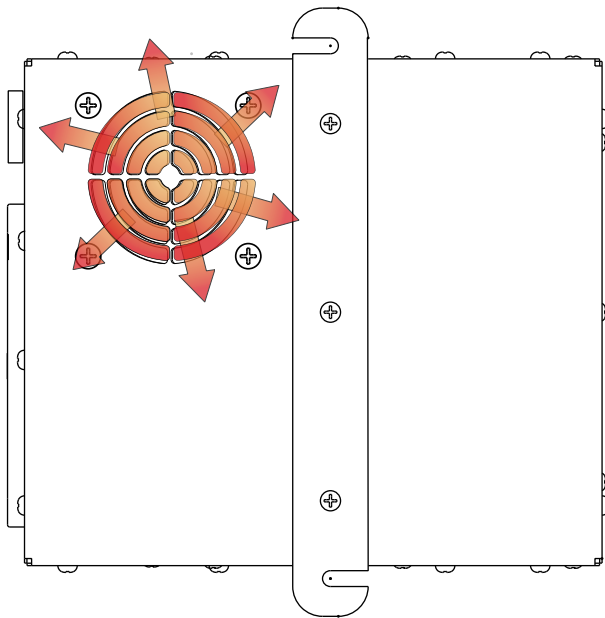

Figure 2.5.1 – Air intake and exhaust ports and internal air circulation

2.6 – Operating Position

The TIUH60 MPU-24 should be operated in the horizontal position as shown. Make sure that the airflow is not obstructed from air intake and outlet.



Top Outlet

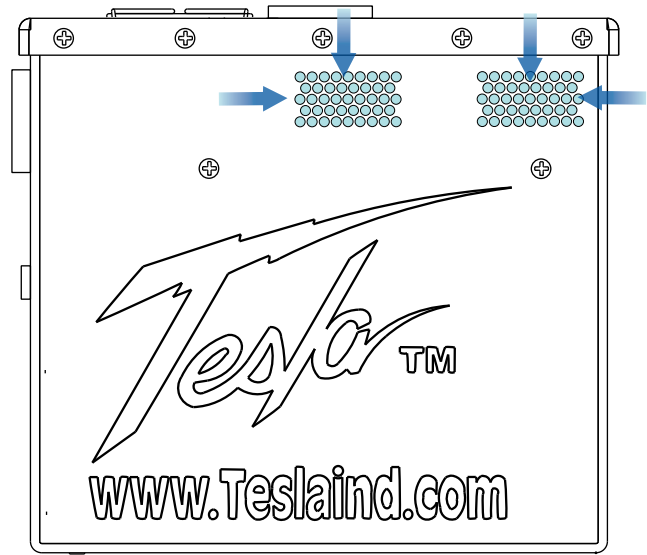

Side Inlet

2.7 – “Press for Capacity” Button and LED Status Indicator

The “Push to Test” button is used to indicate the capacity of the power cells without applying ac input power. It allows the end user to check the status of the power cells. This lets the operator know if there is enough power to perform another engine start, or if the unit has to be connected to ac power to allow it to recharge.

1. Make sure that you wait at least 2 minutes after ac power is applied, or dc power is extracted from the unit, before you press the “Push to Test” button. This will ensure a correct reading.
2. Without ac power input or dc power output, simply press the “Push to Test” button on the faceplate and hold for approximately 2 to 3 seconds.
3. At this time the LED bar graph should light up indicating the status of the power cells.
4. The fan should also operate at this time. If you do not hear the fan running, stop pressing the button and check for any obstructions to the fan.

CAUTION Never press the “Push to Test” button while the unit is plugged into ac power for recharge, or plugged into aircraft for dc power output.

CAUTION Never press the “Push to Test” button for more than 5 seconds. This may cause a temperature sensor to temporarily disrupt “Push to Test” function. (If this sensor is tripped, allow ten minutes for unit to cool before operating “Push to Test” button.)



Figure 2.7.1 “Press for Capacity” button location (outlined in blue)



Figure 2.7.2 Pressing Button

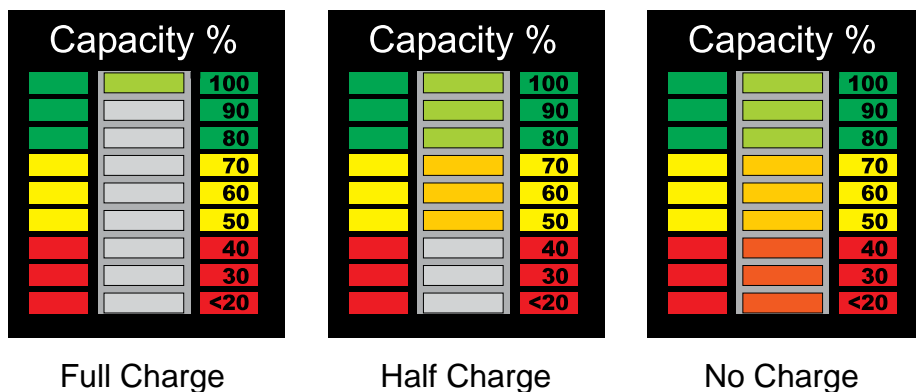

2.8 – Maintenance Check

Check the unit for dents, punctures, case distortion or misalignment, and cracked or loose connectors. Check cables for cuts, chafing or evidence of crushing. Check connectors for cracks, cuts, distortion, excessive wear, broken or loose fasteners, and cables or strain relieves. If no external damage is evident, proceed to next step. Otherwise contact Tesla™ for further instructions.

2.9 – Pre-Installation Procedures

Removing Original Battery

Follow the aircraft's operator manual procedures to remove and dispose of the original aircraft battery properly and safely. Once the original battery has been removed from the battery compartment, proceed to the next step.

Check Unit Charge State

Before installing the TIUH60 MPU-24 into the aircraft, make sure the unit is fully charged. Remove the AC line cord from the AC Input Connector and wait two minutes. Then, push the “Press for Capacity” button to verify that the power cells are fully charged. Under a full charge the Capacity Meter will show a single green LED.



NOTE

If the unit is not fully charged after 74 minutes, the power cells may need to be replaced. Return the unit to Tesla™ Industries for evaluation and maintenance.

2.10 – Installation

Placing and Securing the Unit into the Aircraft.

With the battery compartment empty, maneuver the unit into position. Tilting the front of the unit upward, slide it forward and position it so the Back Mounting Flange slides underneath the receiving lip in the aircraft. Next, lower the front of the unit while making sure the mounting bolts line up with the slotted holes in the two Front Mounting Flanges. Finally, secure the Front Mounting Flanges with the original hardware while wedging the unit against the back mounting lip to ensure a snug fit.

Section 3 – Operating Procedures

3.1 – Operating Procedures

This section deals with normal procedures, and includes all steps necessary to ensure safe and efficient operation of the TIUH60 MPU-24.



NOTE

When the TIUH60 MPU-24 is not in use, it should always remain plugged into a suitable AC power source to insure operational readiness at all times.



NOTE

If current demand exceeds 10 amps, converter output voltage will drop below 28.5 Vdc and two or more LED status indicator bars will illuminate. If all LED status indicator bars illuminate, both the converter and power cells are supplying 24 Vdc power output.

3.2 – General

Correct operation of the TIUH60 MPU-24 includes both pre-use and operational checks of the unit. Knowledge of the operating limits, restrictions, performance, unit capabilities and functions is fundamental to correct and safe operation. The operator shall ensure compliance with the instructions in this manual that affect operational safety and the warranty of the unit.

3.3 – Operating Limits and Restrictions

The minimum, maximum and normal operating ranges result from careful engineering and evaluation of test data. These limitations must be adhered to during all phases of operation.

3.4 – Performance

Refer to Section 7, PERFORMANCE DATA to determine the capability of the TIUH60 MPU-24. Consideration must be given to changes in performance resulting from variations in ambient temperature, mode of operation, state of charge (with or without 120 or 240 Vac power), and aircraft dc bus system inefficiency (voltage drops).

3.5 – Engine Starting Power

Operators should always ensure the unit is charged above 80% prior to ground support engine starting. However, circumstances may exist during use where unit recharge is not readily available and immediate external engine starting power is required. The following provides minimum states of charge necessary to provide ample power for an efficient engine start under specific current load demands.

 NOTE	<p>The ambient temperature may cause the unit’s protective “over-temperature” sensors to shut down the 120-240 AC functions (converter and charger) until the unit cools to normal operating temperatures. If the unit shuts itself down, get the unit into a cooler environment such as shade or air conditioning (if possible). Perform a full function check prior to continued use once the unit is allowed to cool. For continued use in extremely hot environments, it is advised to send the unit back to Tesla™ for recalibration for use in these environments.</p>
---	--

 NOTE	<p>In the event that the temperature sensors do not shut the system down, extended use above specified limits may damage the unit. If the unit is operated when cold or heat soaked temperatures are exceeded, a full functional check should be accomplished prior to continued use.</p>
---	---

<u>ENGINE START PEAK CURRENT Requirements</u>	<u>MINIMUM CHARGE</u>	
300	peak starting amps	40% charged
375	peak starting amps	50% charged
450	peak starting amps	60% charged
525	peak starting amps	70% charged
600	peak starting amps	80% charged
675	peak starting amps	90% charged
750	peak starting amps	100% charged

3.6 – Temperature Specifications

Cold/Hot Soaked Temperature

The ambient temperature that a unit is exposed to for one (1) hour or more establishes the unit’s cold/hot soaked stabilization temperature. If the unit’s cold/hot soaked temperature is outside the normal operating temperature range, the unit must be stabilized prior to operation. For COLD SOAKED temperature stabilization, the unit must be placed in an environment with a temperature above +10°C (+41°F) for 3 hours or a temperature above +20°C (+68°F) for 2 hours. For HOT SOAKED temperature stabilization, the unit must be placed in an environment with a temperature below +38°C (+100°F) for 1 hour.

Cell Storage Capacity

The graph below illustrates the TI60’s available cell capacity as a function of temperature.

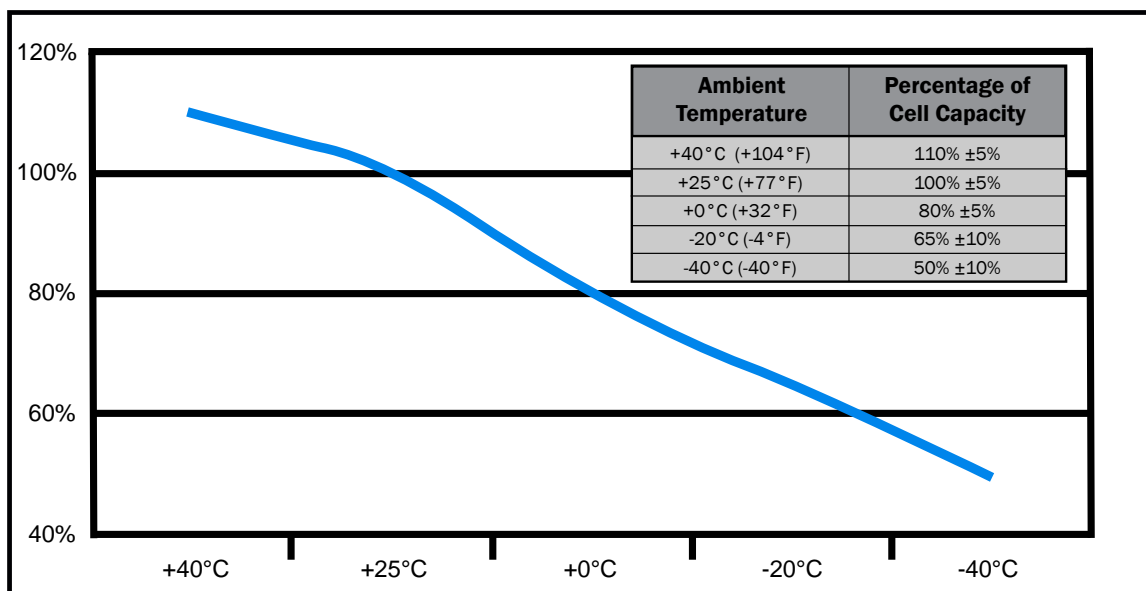



Figure 3.6.1 – Output power capability versus ambient temperature

Hot Soaked or Cold Soaked Definition

Simple terms: When a material is exposed to a change in temperature, its temperature will also change. Some material changes temperature quickly, others slowly. If the ambient temperature changes and is then held constant, the materials temperature will also change until its temperature stabilizes. Once the material temperature has stabilized, it is considered “soaked”.

Example: The unit is moved from the cool shade into the hot sun. The unit’s temperature will increase until it stabilizes. Once stabilized, the unit would be considered “hot soaked”.

	<p>NOTE</p>	<p>The unit is equipped with a temperature switch that automatically disables AC power functions when the internal temperature is above 150°F (65°C). This protects the unit from overheating and damage. If the unit shuts down, move the unit into a cooler climate such as shade or air conditioning when possible. Perform a full function test prior to use after the unit has been allowed to cool.</p>
---	--------------------	---

3.7 – Environmental



WARNING

Operating any electrical equipment in the presence of moisture creates possible safety hazards and/or potential for equipment damage. Every effort has been made, within the scope of existing technology to prevent foreseeable safety hazards and make the unit moisture resistant to prevent damage or failure.

If the unit is exposed to significant moisture, preventive measures and precautions shall be taken to:

- A. Prevent accumulation of moisture on ac and dc connectors/receptacles
- B. Minimize moisture entering forward inlet and outlet cooling fan vent ports

When not in use, unit inlet and outlet vent ports shall be covered from exposure. Unit shall be kept horizontal.

3.8 – Normal Function Test Procedures

This section deals with “normal function” test procedures, and includes all steps necessary to ensure that the TIUH60 MPU-24 is operating within specified parameters prior to use. A digital multimeter (an example is shown in Figure 3.9.1) capable of measuring dc and ac voltage and resistance will be required to perform some of the tests. These functional test procedures should become routine.



Figure 3.8.1 – Digital Multimeter

Check Unit for Evidence of Damage

Check for dents, punctures, case distortion or misalignment, and cracked or loose connectors. If no damage is evident, proceed to the next step. If damage is evident, contact Tesla™ Industries, Inc.

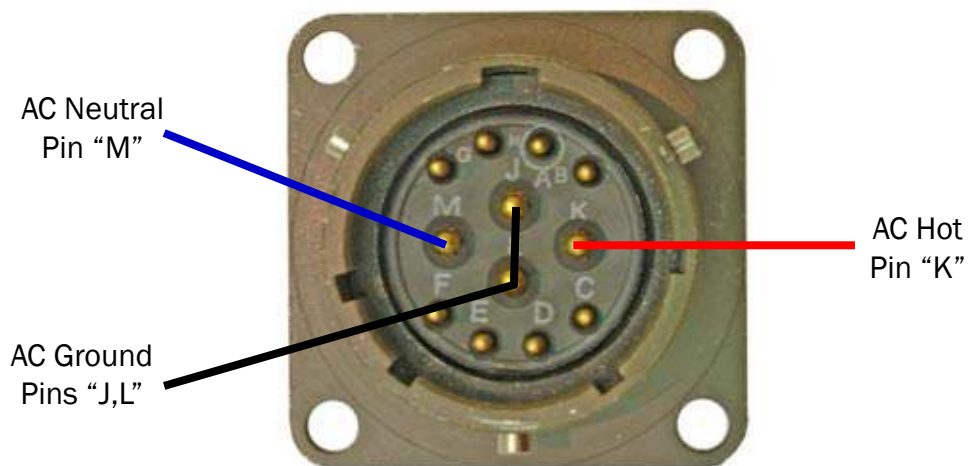

Figure 3.8.2 – AC Input Connector wiring diagram

Check Unit Internal Resistance (Test for Shorts)

This section deals with “normal function” test procedures, and includes all steps necessary to ensure that the TIUH60 MPU-24 is operating within specified parameters prior to use. A digital multimeter (an example is shown in Figure 3.8.1) capable of measuring dc and ac voltage and resistance will be required to perform some of the tests. It is essential to test for shorts to detect any problems with the unit. First, set the multimeter to the “resistance”. Next, test to see if both terminals are isolated from the chassis ground and the line ground using the steps below. In steps 2, 3, 5 and 6, a reading of greater than 10 MΩ will assure no shorts exist. In steps 1 and 4, the multimeter should read less than 1 ohm.



1. Place the negative probe on the ac ground probe (J or L) and the positive probe on an exposed part of the metal case.



2. Move the positive probe to the dc positive post on the DC Output Connector.



3. Move the positive probe to the dc negative post on the DC Output Connector.



4. Move the positive probe to one of the four screws securing the DC Output Connector to the unit casing.



5. Move the negative probe to the dc negative post on the DC Output Connector.



6. Move the negative probe to the dc positive post on the DC Output Connector.

Check DC Voltage Reading at DC Receptacle Terminals

To verify that the power cells are fully charged, set the digital multimeter to measure dc voltage. Place the positive probe (red) on the positive post of the DC Output Connector, as shown in Figure 3.8.3. Next, place the negative probe on the negative post. The multimeter display should read approximately 28.5 Vdc (± 0.5 Vdc) when power cells are fully charged and the unit is plugged into an ac power source. When the unit is not plugged into an ac power source, the multimeter display should read 25.5 Vdc.



Figure 3.8.3 – Testing DC Receptacle

3.9 – Regulated 28.5 Vdc Ground Power

Connecting DC Power Cable To Unit

Ensure DC power cable plug is fully seated into the MPU's DC Battery Receptacle. Attaching a DC plug is quick and easy. Line up the plug with the receptacle. Push forward while rotating the T-handle one full turn clockwise. The unit is now ready to safely transfer power.



Figure 3.9.1 Attaching DC Power Cable to TIUH60 MPU-24

3.10 – Regulated AC Power

Plugging in with AC Power

When the TIUH60 MPU-24 is plugged into ac power, the output is 28.5 volts. This voltage allows the system to recondition and recharge the aircraft's battery(ies). It is also an optimum voltage for powering avionics and lighting on most aircraft. The MPU's ac to dc converter produces continuous amps of dc power depending on the size of the system.

Ensure 120 or 240 Vac power cord is properly connected to an approved ac power supply. After approximately 5-8 seconds, unit's LED status indicator will illuminate indicating power cell state of charge. Cooling fan will operate. Ensure LED status indicator and cooling fan is operational prior to continuing.



Figure 3.10.1 Connecting TI60 to AC Power Supply

Connect DC Power To Aircraft (Low Power Demand)

Low power demand is defined by a requirement of 10 amps or less. Connect dc power to aircraft ground power receptacle. DC bus power should come on and aircraft voltmeter should indicate 28.5 Vdc to 27 Vdc (26.5 Vdc minimum). If aircraft power demand is less than 5 amps converter output will remain at 28.5 Vdc (only one GREEN LED status indicator bar will illuminate). If aircraft power demand exceeds 10 amps converter voltage output will decrease and two or more LED status indicator bars will illuminate.

Connect DC Power To Aircraft (High Power Demand)

High power demand is defined by a requirement of greater than 10 amps. Connect to aircraft ground power receptacle. DC bus power should come on and aircraft voltmeter should indicate 28.5 Vdc to 23.5 Vdc (23 VDC minimum). If current demand is greater than 10 amps, converter output voltage will drop below 28.0 Vdc and LED status indicator lights will illuminate indicating current is being drawn from the power cells. The greater the current draw, the quicker the LED status indicator will approach red. Note the LED status indicator shows the status of the power cells.



NOTE

When all LED status indicator bars illuminate, both the converter and power cells are supplying 24 Vdc power output for current demands above 10 amps.

Engine Starting

UNPLUG AC POWER CORD BEFORE STARTING ENGINE WITH TIUH60 MPU-24

Prior to engine start, ensure power cell charge is sufficient to provide an efficient engine start. Users should follow ground power engine starting procedures as specified in the aircraft's operator manual.

3.11 – Charging Unit

Attaching AC Input Power

Before plugging the line cord into an ac outlet, attach and lock the mating plug to the AC Input Connector. Once accomplished, the unit can be plugged into an electrical outlet to begin charging. The Capacity Meter will immediately show the current charge state of the power cells. Make sure there is at least 2 to 3 inches of clearance in the front of the Air Exhaust Fan to provide for sufficient ventilation. If the unit is completely discharged, a minimum of 143 minutes will be required to fully recharge the unit.



Figure 3.11.1 AC Input Connector (outlined in blue)

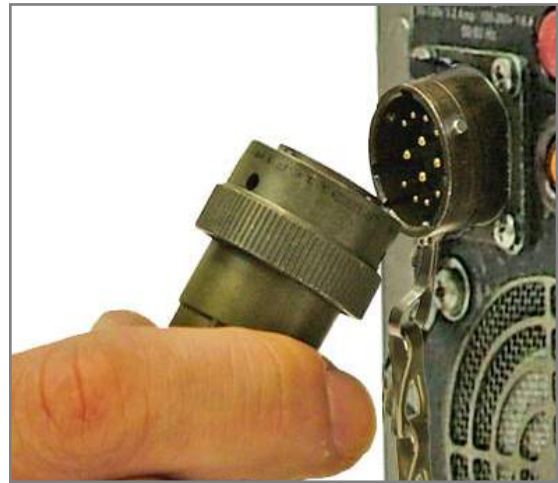
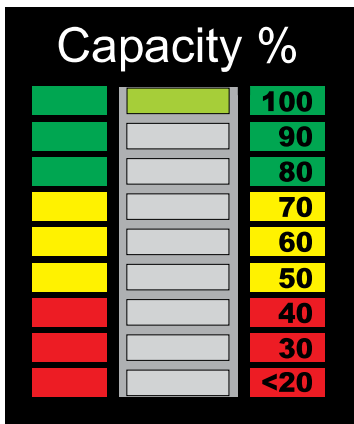

Figure 3.11.2 Attaching AC Line Cord

LED and Fan Activity

Initially, several LEDs will be illuminated on the Capacity Meter. As the unit charges, the LEDs will go out one by one. Under full charge, the Meter will show either a single solid or pulsating green LED. In addition, the fan will be running at reduced RPM. This indicates that the unit is in standby mode and ready for use.



Full Charge

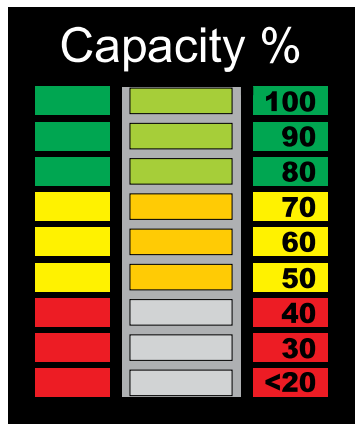

Half Charge

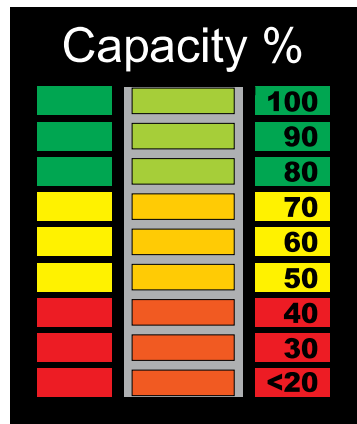

No Charge

Section 4 – Post Operation

4.1 – General

Although the TIUH60 MPU-24 has been ruggedized and made weather resistant within the scope of unit's intended use, it is essential that good general care be taken to maintain unit in good operating condition and to maximize unit's operational life.

4.2 – After Use

Unit should be protected from environmental elements and man made hazards. Ideally unit should be secured in a building or shed. Most importantly, unit shall be fully covered if stored while exposed to environmental elements.

4.3 – Power Cell Recharge

When Installed in an operating aircraft, the TIUH60 MPU-24 will back-charge from the aircraft's dc power. Otherwise, the TIUH60 MPU-24 has an intelligent recharging system that will enable it to rapidly recharge when connected to an ac power source. If the unit's power cells become fully discharged, the unit should be recharged within 24 hours to ensure maximum life and performance. Under normal circumstances a minimum of 74 minutes will be required to fully recharge the unit.

 NOTE	Plug the TIUH60 MPU-24 into ac power to keep the cells charged whenever it is not in use, even if it is at Full Charge. The unit will not overcharge or overheat.
---	---

Connect AC Power Cord to Unit

Ensure 120 or 240 Vac power cord is properly connected to an approved ac power supply. After approximately 5-8 seconds, ensure unit's LED status indicator illuminates indicating power cell state of charge and cooling fan is operating.



Figure 4.3.1 Connecting TIUH60 MPU-24 to AC Power Supply

**CAUTION****Guard From Incorrect Power Source**

The TIUH60 MPU-24's power cells may be damaged if recharged by NiCad or Lead Acid-type battery chargers. Power cells should only be charged by either the TIUH60 MPU-24's internal charger and the ac power cord furnished with the equipment, or when connected to aircraft's external dc power receptacle.



Figure 4.3.2 Proper and Improper Charging Methods

Section 5 – Unit Care and Maintenance



DANGER

Severe injury or death from electrical shock will occur if either the user or the unit is wet while operating the unit with an AC power source attached.



CAUTION

Damage may occur if an unapproved or modified AC line cable or input plug is attached to the MPU. Do not use any type of AC voltage converter.

5.1 - Unit Care

Avoid Prolonged Exposure to Extremely Damp Environments

Be sure to disconnect ac power from the ac source if the TIUH60 MPU-24 has come into contact with water. If the AC Input Circuit Breaker has tripped due to water infiltration, allow the unit to dry out before attempting to reset circuit breaker. Cover the unit to prevent water seepage. If the unit is operated in extremely damp conditions, it should be stored in an environmentally controlled building when not in use. Wipe unit clean periodically with a soft cloth to remove dust, dirt, etc.



Protect Cables from Damage

Do not cut, crush, or drag the input or output power cables when handling the TIUH60 MPU-24. Always inspect cables prior to use. If no damage is evident, proceed to the next step. If damage is evident, contact Tesla™ Customer Service. Do not attempt to use any other type of power cables other than the Tesla™ cables included with the TIUH60 MPU-24.



Figure 5.1.1 – Damaged cable

5.2 – Unit Servicing

The TIUH60 MPU-24 is a maintenance-free, sealed unit. No repairs outside of Tesla™ are authorized. Warranty will be voided if unit is tampered with in any way including any damage to the WARRANTY VOID stickers located on the case (see Figure 5.2.1 below). If the unit requires maintenance, please contact Tesla™ Customer Service at (302) 324-8910. A Repair Request Form can be found in the back of this manual.



Figure 5.2.1 – Warranty Void stickers on the TIUH60 MPU-24

5.3 – Packaging and Shipping

When returning the MPU, please ensure that it is properly packaged. The only method for transport is in a sturdy shipping crate or Tesla™ Shipping Case (be sure to enclose the Repair Request Form). Seal the crate on all sides and return it to Tesla™ at the address listed below. Please contact Tesla™ Customer Service at (302) 324-8910 with any questions or concerns.

TESLA™ INDUSTRIES, INCORPORATED
101 CENTERPOINT BLVD.
CENTERPOINT INDUSTRIAL PARK
NEW CASTLE, DELAWARE 19720
PHONE: (302) 324-8910 FAX: (302) 324-8912
Website: www.teslaind.com Email: Tesla1@teslaind.com

Section 6 – Frequently Asked Questions

1. Why should I buy a Tesla™ TIUH60 MPU-24?

Tesla™ MPU has dramatic advantages over standard aircraft batteries. The advantages include power, durability, and longevity. A Tesla™ MPU will provide more power for testing avionics and starting than comparable competitors. The dry cells are more resistant to heat and vibration. A Tesla™ MPU does not experience thermal runaway. A Tesla™ MPU is equipped with a built in intelligent charger.

2. Do the cells have memory?

The cells have no memory. The user can plug the TIUH60 MPU-24 into AC for charging regardless of the unit's current state of charge. The intelligent charger will keep a fully charged battery by trickle charging. Keeping a fully charged TIUH60 MPU-24 plugged into AC when not in use will prolong the life of the batteries.

3. How are Micro Power Units used in Aviation Support?

There are many ways a MPU will benefit your operation. By using it for pre-flight testing, you will avoid depleting the aircraft's battery. You can start the aircraft's engine with the MPU as well. In the hangar, when connected to AC power, the MPU will provide 28.5 Vdc for avionics testing and will also recondition and recharge the aircraft's battery.

4. How much power will my TIUH60 MPU-24 provide?

The MPU will provide up to 10 continuous amps with AC line voltage and 1500 peak starting amps directly from the internal cells.

5. How many engine starts will my MPU provide until it is depleted?

The MPU back-charges, almost instantly, once the aircraft is started and the generator is on line. This "power flywheel" feature enables the MPU to recharge itself right from the aircraft it started in less than 30 seconds.

6. How do you prolong the life of the TIUH60 MPU-24's cells?

All you need to do is plug the unit in to the appropriate AC power outlet the system requires. AC power will recharge the system and keep the cells healthy. Users who regularly plug the system in can expect to get 5-7 years from their cells before they need to be replaced.

7. Is it waterproof?

Water-resistant but not waterproof. See Section 3.7 for further information.

8. Why does the cooling fan run continuously when the MPU is plugged into AC power? Why does the cooling fan slow down?

The cooling fan speed varies to regulate the temperature of the internal circuitry when plugged into an AC power source.

9. Can one person transport it?

Micro Power Units are designed to be handled by one person. The TIUH60 MPU-24 provides a rugged nylon strap attached to the top of the unit that helps easily transport and place into the aircraft. See Section 3.8 for more information.

10. Is the TIUH60 MPU-24 in the government purchasing system?

Yes. Tesla™ Industries is an approved vendor/supplier – our cage code is OVWE2. Most Tesla™ products are class IX, have a National Stock Number (NSN) designation and can be acquired through the Defense Logistics Agency (DLA).

11. How long does this unit stay charged?

Unit should never be allowed to discharge fully. In-field use, it receives a dc back charge directly from a running engine. When not in use, unit should be plugged into ac power (outlet) all the time. Tesla™ systems will retain 80% of their capacity after one year of storage.

12. How do I get my TIUH60 MPU-24 serviced?

Contact Tesla™ at (302) 324-8910. Ask for customer service. You can also email us at tesla1@teslainsd.com. Once we receive the unit at our facility, we will examine it. Systems that are protected under warranty will be repaired at no charge. If the warranty has expired, you will receive a quote for necessary repairs prior to work being done. Our turnaround time is 48 hours once repairs are authorized.

13. Can I make my own repairs to unit?

During the warranty period, the unit can only be repaired by Tesla™ Industries for the warranty to remain in effect. Regardless, we strongly recommend allowing Tesla™ to repair any unit as we will analyze the complete system and re-calibrate it.

14. What type of maintenance does the TIUH60 MPU-24 require?

Although the systems are maintenance free, please keep units plugged in while not in use. This will greatly extend the life of the cells. Also, keep the vent areas clean and free of debris. Keep units in a well ventilated area while charging. Keep the unit in a protected environment when not in use (maintenance facility, shed).

15. What is included with my TIUH60 MPU-24?

Customers receive an AC line cord for their home country and a full three year warranty.

16. Are there any HAZMAT issues or disposability problems?

There are none. Tesla™ will reclaim all battery cells for disposability purposes. Contact Tesla™ if you have questions.

6.2 - Basic Usage/Operation Questions

1. What's the best position to place the unit for use?

The only position for the MPU is the upright position for stability and airflow considerations.

2. Does the unit have to be plugged in all the time?

No, but for maximum performance and cell longevity, keep the unit plugged in while not in use.

3. What happens if I don't keep it plugged in?

Unit will eventually lose its charge and cell life is shortened.

4. How do I check the status of the charge?

Press the "Push to Test" LED bar indicator on the unit's faceplate. A fully charged unit will have one green LED light showing.

5. Why is the cooling fan always running when I am plugged into AC power?

Constant cooling fan operation ensures proper and consistent ventilation of the unit.

6. Why does the cooling fan slow down?

Cooling fan rpm varies for better temperature regulation.

7. Why does my LED flicker when the unit is plugged in?

Older Turbo Starts™ indicated a full charge with a flickering LED readout. Newer models feature the illumination of one green bar on the LED readout when the unit is fully charged.

8. What do I do if a circuit breaker trips?

The AC input circuit breaker is located above the AC Input Connector. When the circuit breaker has been tripped, either of the red buttons will pop out. In the event that the breaker trips:

1. Disconnect the ac and dc connectors. (Unplug ac line cord on unit.)
2. Wait for a minimum of 60 seconds.
3. Reset breaker by pressing red button.
4. Reconnect ac and dc connections to the unit. (Plug in ac line cord on unit.)

The unit should power up automatically. If the breaker continues to trip, return the unit to Tesla™ Industries for repair.

Section 7 – Optional Accessories

7.1 – Tesla™ AC Line Cords

AC line cords come in several lengths or can be custom-ordered to fit your needs. Tesla™ specializes in outfitting cables with a variety of connectors and junction boxes. Contact Tesla™ customer service to find out more about our selection of cords.

Universal Line Cords

- TI25000-111 **North American Line Cord**
105-125 Vac 60 Hz 6.50 amps max
NSN: 5935-01-576-4422 (CL IX)
- TI25000-112 **Italian Line Cord**
10A/250V
- TI25000-113 **European Line Cord**
10A/250V-210-250 Vac 50/60 Hz 3.25 amps max
- TI25000-114 **Old British Line Cord**
210-250 Vac 50/60 Hz 3.25 amps max
- TI25000-115 **England Line Cord**
10A/250- 210/250 Vac 50/60 Hz 3.25 amps max
- TI25000-120 **Israel Line Cord**
6/10A/250V



APPENDIX A

OPTIONAL LINE CORDS FOR WORLDWIDE OPERATIONS

<u>COUNTRY</u>	<u>VOLTS</u>	<u>HZ</u>	<u>TESLA™ PART #</u>
Afghanistan	220	50	TI25000-004 Old British Line Cord
Algeria	220	50	TI25000-004 Old British Line Cord
American Samoa	240	60	TI25000-011 Australian Line Cord
Angola	220	50	TI25000-003 Continental European Line Cord
Anguilla (U.K.)	240	50	TI25000-005 United Kingdom Line Cord
Antigua	230	60	TI25000-005 United Kingdom Line Cord
Argentina	220	50	TI25000-011 Australian Line Cord
Aruba	115	60	TI25000-001 North American Line Cord
Australia	240	50	TI25000-011 Australian Line Cord
Austria	220	50	TI25000-003 Continental European Line Cord
Azores (Portugal)	220	50	TI25000-004 Old British Line Cord
Bahamas	120	60	TI25000-001 North American Line Cord
Bahrain	220	50	TI25000-005 United Kingdom Line Cord
Bangladesh	220	50	TI25000-004 Old British Line Cord
Barbados	115	50	TI25000-001 North American Line Cord
Belgium	220	50	TI25000-003 Continental European Line Cord
Belize (Br. Hond.)	110	60	TI25000-001 North American Line Cord
Benin	220	50	TI25000-004 Old British Line Cord
Bermuda	120	60	TI25000-005 United Kingdom Line Cord
Bolivia	220	50	TI25000-003 Continental European Line Cord
Botswana	220	50	TI25000-005 United Kingdom Line Cord
Brazil	110	60	TI25000-001 North American Line Cord
Bulgaria	220	50	TI25000-003 Continental European Line Cord
Burkina Faso	220	50	TI25000-003 Continental European Line Cord
Burma (Now Myanmar)	230	50	TI25000-005 United Kingdom Line Cord
Burundi	220	50	TI25000-003 Continental European Line Cord
Cambodia	220	50	TI25000-003 Continental European Line Cord
Cameroon	230	50	TI25000-003 Continental European Line Cord
Canada	120	60	TI25000-001 North American Line Cord
Canary Islands (Spain)	220	50	TI25000-003 Continental European Line Cord
Cape Verde, Rep. of	220	50	TI25000-003 Continental European Line Cord
Cayman Islands	120	60	TI25000-001 North American Line Cord
Central African Republic	220	50	TI25000-003 Continental European Line Cord
Chad	220	50	TI25000-003 Continental European Line Cord
Channel Islands	240	50	TI25000-005 United Kingdom Line Cord
Chile	220	50	TI25000-002 Italian Line Cord
China, Peoples Republic of	220	50	TI25000-011 Australian Line Cord
Christmas Island (Australia)	240	50	TI25000-011 Australian Line Cord
Cocos Islands (Australia)	240	50	TI25000-011 Australian Line Cord
Columbia	220	60	TI25000-003 Continental European Line Cord
Congo, Republic of	220	50	TI25000-003 Continental European Line Cord
Cook Island (New Zealand)	240	50	TI25000-011 Australian Line Cord
Costa Rica	120	60	TI25000-001 North American Line Cord
Curacao Islands	110	60	TI25000-001 North American Line Cord
Cyprus	240	50	TI25000-005 United Kingdom Line Cord
Czech, Republic of	220	50	TI25000-003 Continental European Line Cord
Denmark	220	50	TI25000-300 Denmark Line Cord
Djibouti, Republic of	220	50	TI25000-003 Continental European Line Cord
Dominica	230	50	TI25000-005 United Kingdom Line Cord
Dominican Republic	110	60	TI25000-001 North American Line Cord

APPENDIX A (Cont.)

OPTIONAL LINE CORDS FOR WORLDWIDE OPERATIONS

<u>COUNTRY</u>	<u>VOLTS</u>	<u>HZ</u>	<u>TESLA™ PART #</u>
Ecuador	120	60	TI25000-001 North American Line Cord
Egypt	220	50	TI25000-003 Continental European Line Cord
El Salvador	115	60	TI25000-001 North American Line Cord
England	240	50	TI25000-005 United Kingdom Line Cord
Equatorial Guinea	220	50	TI25000-003 Continental European Line Cord
Estonia	220	50	TI25000-003 Continental European Line Cord
Ethiopia	220	50	TI25000-003 003 Continental European Line Cord
Fiji	240	50	TI25000-011 Australian Line Cord
Finland	220	50	TI25000-003 Continental European Line Cord
France	220	50	TI25000-003 Continental European Line Cord
French Guiana	220	50	TI25000-003 Continental European Line Cord
Gabon	220	50	TI25000-003 Continental European Line Cord
Gambia	220	50	TI25000-005 United Kingdom Line Cord
Georgia	220	50	TI25000-003 Continental European Line Cord
Germany	220	50	TI25000-003 Continental European Line Cord
Ghana	220	50	TI25000-005 United Kingdom Line Cord
Gibraltar	240	50	TI25000-005 United Kingdom Line Cord
Greece	220	50	TI25000-003 Continental European Line Cord
Greenland (Denmark)	220	50	TI25000-300 Denmark Line Cord
Grenada	230	50	TI25000-005 United Kingdom Line Cord
Guadeloupe	220	50	TI25000-003 Continental European Line Cord
Guam	110-120	60	TI25000-001 North American Line Cord
Guatemala	120	60	TI25000-001 North American Line Cord
Guinea	220	50	TI25000-003 Continental European Line Cord
Guinea-Bissau	220	50	TI25000-003 Continental European Line Cord
Guyana	110	50/60	TI25000-001 North American Line Cord
Haiti	110-120	50-60	TI25000-001 North American Line Cord
Honduras	110	60	TI25000-001 North American Line Cord
Hong Kong	220	50	TI25000-005 United Kingdom Line Cord
Hungary	220	50	TI25000-003 Continental European Line Cord
Iceland	220	50	TI25000-003 Continental European Line Cord
India	220-250	50	TI25000-004 Old British Line Cord
Indonesia	220	50	TI25000-003 Continental European Line Cord
Iran	220	50	TI25000-003 Continental European Line Cord
Iraq	220	50	TI25000-005 United Kingdom Line Cord
Ireland, Republic of	220	50	TI25000-005 United Kingdom Line Cord
Isle of Man	240	50	TI25000-005 United Kingdom Line Cord
Israel	230	50	TI25000-200 Israel Line Cord
Italy	220	50	TI25000-002 Italian Line Cord
Ivory Coast	220	50	TI25000-003 Continental European Line Cord
Jamaica	110	50	TI25000-001 North American Line Cord
Japan	110	50/60	TI25000-001 North American Line Cord
Jordan	220	50	TI25000-005 United Kingdom Line Cord
Kenya	240	50	TI25000-005 United Kingdom Line Cord
Korea, South	220	60	TI25000-003 Continental European Line Cord
Kuwait	240	50	TI25000-005 United Kingdom Line Cord

APPENDIX A (Cont.)

OPTIONAL LINE CORDS FOR WORLDWIDE OPERATIONS

<u>COUNTRY</u>	<u>VOLTS</u>	<u>HZ</u>	<u>TESLA™ PART #</u>
Laos	220	50	TI25000-001 North American Line Cord
Latvia	220	50	TI25000-003 Continental European Line Cord
Lebanon	220	50	TI25000-003 Continental European Line Cord
Lesotho	240	50	TI25000-004 Old British Line Cord
Liberia	120	60	TI25000-005 United Kingdom Line Cord
Liechtenstein	220	50	TI25000-006 Switzerland Line Cord
Lithuania	220	50	TI25000-003 Continental European Line Cord
Luxembourg	220	50	TI25000-003 Continental European Line Cord
Libya	230	50	TI25000-002 Italian Line Cord
Macao	220	50	TI25000-004 Old British Line Cord
Madagascar	220	50	TI25000-003 Continental European Line Cord
Maderia (Portugal)	220	50	TI25000-004 Old British Line Cord
Majorca	220	50	TI25000-003 Continental European Line Cord
Malawi	230	50	TI25000-005 United Kingdom Line Cord
Malaysia	240	50	TI25000-005 United Kingdom Line Cord
Maldives	230	50	TI25000-004 Old British Line Cord
Mali, Republic of	220	50	TI25000-003 Continental European Line Cord
Malta	240	50	TI25000-005 United Kingdom Line Cord
Martinique	220	50	TI25000-003 Continental European Line Cord
Mauritania	220	50	TI25000-003 Continental European Line Cord
Mauritius	230	50	TI25000-005 United Kingdom Line Cord
Mexico	127	60	TI25000-001 North American Line Cord
Monaco	220	50	TI25000-003 Continental European Line Cord
Mongolia	220	50	TI25000-003 Continental European Line Cord
Montseurrat	230	60	TI25000-005 United Kingdom Line Cord
Morocco	220	50	TI25000-003 Continental European Line Cord
Mozambique	220	50	TI25000-003 Continental European Line Cord
Namibia (W.S. Africa)	220-250	50	TI25000-004 Old British Line Cord
Nepal	220	50	TI25000-004 Old British Line Cord
Neth. Antilles	220	50/60	TI25000-003 Continental European Line Cord
Netherlands	220	50	TI25000-003 Continental European Line Cord
New Caledonia	220	50	TI25000-003 Continental European Line Cord
New Zealand	230	50	TI25000-011 Australian Line Cord
Nicaragua	120	60	TI25000-001 North American Line Cord
Niger	220	50	TI25000-003 Continental European Line Cord
Nigeria	230	50	TI25000-005 United Kingdom Line Cord
Norfolk Islands (Australia)	240	50	TI25000-011 Australian Line Cord
North Ireland	220	50	TI25000-005 United Kingdom Line Cord
North Mariana Islands (U.S.)	115	60	TI25000-001 North American Line Cord
Norway	220	50	TI25000-003 Continental European Line Cord
Okinawa	100-120	60	TI25000-001 North American Line Cord
Oman	240	50	TI25000-005 United Kingdom Line Cord
Pakistan	230	50	TI25000-004 Old British Line Cord
Panama	110	60	TI25000-001 North American Line Cord
Papua New Guinea	240	50	TI25000-011 Australian Line Cord
Paraguay	220	50	TI25000-003 Continental European Line Cord
Peru	110	50/60	TI25000-001 North American Line Cord
Philippines	115	60	TI25000-001 North American Line Cord
Piccairn Islands (U.K.)	240	50	TI25000-004 Old British Line Cord
Poland	220	50	TI25000-003 Continental European Line Cord
Portugal	220	50	TI25000-003 Continental European Line Cord
Puerto Rico	120	60	TI25000-001 North American Line Cord

APPENDIX A (Cont.)

OPTIONAL LINE CORDS FOR WORLDWIDE OPERATIONS

<u>COUNTRY</u>	<u>VOLTS</u>	<u>HZ</u>	<u>TESLA™ PART #</u>
Romania	220	50	TI25000-003 Continental European Line Cord
Russia	220	50	TI25000-003 Continental European Line Cord
Rwanda	220	50	TI25000-003 Continental European Line Cord
Saudi Arabia	220	50/60	TI25000-003 Continental European Line Cord
Scotland	220	50	TI25000-005 United Kingdom Line Cord
Senegal	220	50	TI25000-003 Continental European Line Cord
Seychelles	240	50	TI25000-005 United Kingdom Line Cord
Sierra Leone	230	50	TI25000-005 United Kingdom Line Cord
Singapore	230	50	TI25000-005 United Kingdom Line Cord
Slovakia	220	50	TI25000-003 Continental European Line Cord
Somalia	220	50	TI25000-003 Continental European Line Cord
South Africa	220-250	50	TI25000-004 Old British Line Cord
Spain	220	50	TI25000-003 Continental European Line Cord
Sri Lanka	230	50	TI25000-004 Old British Line Cord
St. Pierre & Miquelon (France)	115	60	TI25000-001 North American Line Cord
St. Kitts & Nevis	230	60	TI25000-005 United Kingdom Line Cord
St. Lucia	240	50	TI25000-005 United Kingdom Line Cord
St. Vincent	230	50	TI25000-005 United Kingdom Line Cord
Sudan	240	50	TI25000-005 United Kingdom Line Cord
Surinam	115	60	TI25000-003 Continental European Line Cord
Svalbard (Norway)	220	50	TI25000-003 Continental European Line Cord
Swaziland	230	50	TI25000-004 Old British Line Cord
Sweden	220	50	TI25000-003 Continental European Line Cord
Switzerland	220	50	TI25000-006 Switzerland Line Cord
Syria	220	50	TI25000-003 Continental European Line Cord
Tahiti	220	50	TI25000-003 Continental European Line Cord
Taiwan	110	60	TI25000-001 North American Line Cord
Tanzania	230	50	TI25000-005 United Kingdom Line Cord
Thailand	220	50	TI25000-003 Continental European Line Cord
Togo	220	50	TI25000-003 Continental European Line Cord
Tonga	115	60	TI25000-004 Old British Line Cord
Trinidad & Tobago	230	60	TI25000-005 United Kingdom Line Cord
Tunisia	220	50	TI25000-003 Continental European Line Cord
Turkey	220	50	TI25000-003 Continental European Line Cord
Uganda	220	50	TI25000-004 Old British Line Cord
United Arab Emir.	220	50	TI25000-005 United Kingdom Line Cord
United Kingdom & Ireland	240	50	TI25000-005 United Kingdom Line Cord
United States	120	60	TI25000-001 North American Line Cord
Uruguay	220	50	TI25000-011 Australian Line Cord
Venezuela	120	60	TI25000-001 North American Line Cord
Vietnam	220	50	TI25000-003 Continental European Line Cord
Virgin Islands	120	60	TI25000-001 North American Line Cord
Wales	220	50	TI25000-005 United Kingdom Line Cord
Western Samoa	230	50	TI25000-005 United Kingdom Line Cord
Yemen	220	50	TI25000-005 United Kingdom Line Cord
Yugoslavia	220	50	TI25000-003 Continental European Line Cord
Zaire, Republic of	220	50	TI25000-003 Continental European Line Cord
Zambia	220	50	TI25000-005 United Kingdom Line Cord
Zimbabwe	220	50	TI25000-005 United Kingdom Line Cord

APPENDIX A (Cont.)

UNIVERSAL LINE CORD KIT FOR WORLDWIDE OPERATIONS

NOTE: TESLA™ UNIVERSAL AC LINE CORD KIT, P/N: **TI25000-U00**, IS FOR UNITS ORIGINALLY BUILT WITH THE UNIVERSAL AC LINE CORD OPTION ONLY.

THE AC ADAPTER OPTION IS TESLA™ P/N **TI16000-19** AND MUST BE ORDERED WITH THE ORIGINAL PROCUREMENT OF UNIT(S). UNIT(S) MAY BE RETURNED TO TESLA™ INDUSTRIES, FOR A NOMINAL COST, AND MODIFIED TO ALLOW OPERATION WITH THE UNIVERSAL AC LINE CORD KIT.

TESLA™ UNIVERSAL AC LINE CORD KIT, P/N: **TI25000-U00**, IS COMPRISED OF THE FOLLOWING FIVE PART NUMBERS:

TI25000-111	NORTH AMERICAN LINE CORD
TI25000-113	EUROPEAN 10A/250V
TI25000-114	OLD BRITISH LINE CORD
TI25000-115	ENGLAND 10A/250V
TI7000-131	LINE CORD POUCH

Repair Request Form

Please complete the information below to ensure prompt and accurate service. Include this form with the unit you are returning. Thank you.

Date of return: _____

Company name & _____

Billing address: _____

Contact person: _____

Phone #: _____ Fax #: _____

Email: _____

Purchase Order #: _____

Model #: _____ Serial #: _____

Model #: _____ Serial #: _____

Shipping method to Tesla™: _____

Description of shipping package: _____

Description of problem: _____

Return to Tesla™ Industries, Inc.

101 Centerpoint Boulevard, New Castle, DE 19720 Attention: Repair Department



WE GET THE MILITARY STARTED!

Tesla™ Industries, Inc.

101 Centerpoint Blvd.
New Castle, DE 19720 USA
Tel: 302-324-8910
Fax: 302-324-8912

9475 Double R Blvd., Suite 2
Reno, NV 89521
Tel: 775-622-8801
Fax: 775-622-8810

www.teslaind.com

TIUH60 MPU-24

The Tesla™ TIUH60 Micro Power Unit is a complete battery system that incorporates patented power cell technology with an intelligent charging system and ac-dc converter. Specifically designed to fit the UH-60 Black Hawk Helicopter, the TIUH60 provides faster, cooler aircraft starts while eliminating the problems normally associated with aviation batteries and battery maintenance. The TIUH60 provides more power than comparable NiCd batteries with no risk of thermal runaway. Plus, Tesla™ stands behind the TIUH60 with a three-year warranty, a trained military support team, and an experienced staff of customer service professionals.



Power Anytime, Anywhere

Features:

- Rated to 750 peak starting amps
- Maintenance-free design
- 10 amps continuous @ 28.5 Vdc (when plugged into ac power)
- 21.5 amp hours (541 watt hours) with ac Power
- 11.5 amp hours (256 watt hours) of rechargeable battery power without ac power
- 5 to 7-year service life with a 3-year warranty
- Non-hazardous, dry-cell technology
- Built in Capacity Meter/Recharge State Indicator
- Plugs into ac power to recharge cells



Tesla™ Industries, Inc.

www.teslaind.com

Email: tesla1@teslaind.com

Headquarters: (302) 324-8910

101 Centerpoint Blvd. New Castle, DE 19720 USA

Western Regional Office: (775) 622-8801

9475 Double R Blvd. Suite 2, Reno, NV 89521 USA



**The POWER
Of
RED™**



Dimensions and Technical Specifications

* All dimensions are in inches [millimeters]

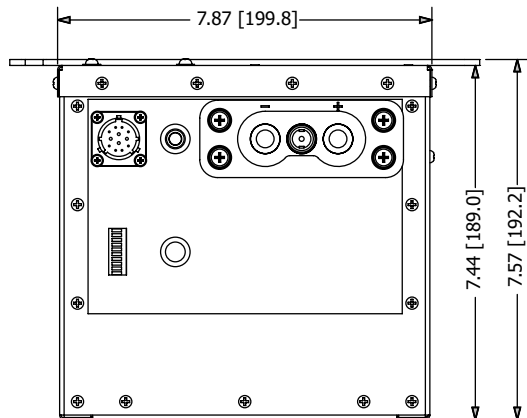

Front View

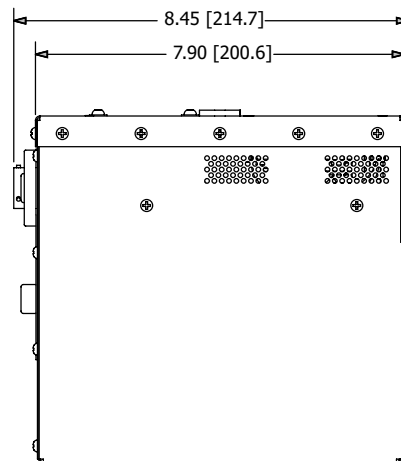

Side View

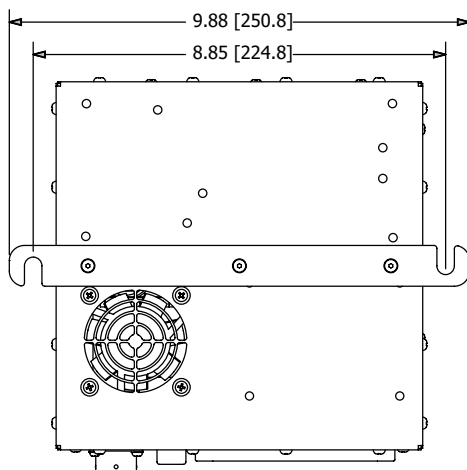

Top View

Technical Specifications:

Peak Starting Amps	750 A
Storage Temperature	-65 °C to +105 °C (-85 °F to 221 °F)
Operating Temperature with AC	-40 °C to +55 °C (-40 °F to 131 °F)
Operating Temperature without AC	-40 °C to +60 °C (-40 °F to 140 °F)
DC Output - Continuous	28.5 Vdc @10 amps
AC Input Power	5.5 amps @ single phase 120 Vac 60 Hz 2.75 amps @ single phase 240 Vac 60 Hz
Recharging Rate	74 minutes @ 25 °C
Shock	50 G
Vibration	Exceeds MIL-STD-810F
Weight	27 lbs (12.25 kg)
Warranty	3 years



Front View