



JUPITER AVIONICS
CORPORATION

wj JAC-Pxx (JA64/JA65)

**Wireless Stand Alone
Intercom System**



Operating Manual

Rev. A



**Copyright 2014 Jupiter Avionics Corp.
 All rights reserved**

Jupiter Avionics Corporation (JAC) permits a single copy of this manual to be printed or downloaded for personal use. Any such electronic or printed copy of this manual must contain the complete text of this copyright notice. Any unauthorized commercial distribution of this manual is strictly prohibited. Except as described above, no part of this manual may be reproduced, copied, transmitted, disseminated, downloaded, or stored in any storage medium for any purpose without the express prior written consent of JAC.

IMPORTANT:

**Information in this manual is subject to change
 without notice.**

To check the current revision status of
 this manual, visit the JAC website:

www.jupiteravionics.com

Record of Revisions

Rev	Date	Description	ECR
A	Dec 2014	Initial release, serial number 1001 +	2543



Prepared: MPB	Checked: 	Approved: 
----------------------	---	--



Table of Contents

1	Introduction.....	1
1.1	Unpacking	1
1.2	Verify Operating Region	1
2	Headset Adapter Master/Slave (JA65/JA64).....	2
3	Controls, Annunciators and Connectors.....	2
3.1	⏻ (ON/OFF) Button.....	2
3.2	VOX (Voice Operated Switch).....	3
3.3	VOL (Phones Volume Control).....	3
3.4	ICS PTT (Push To Talk) Button.....	3
3.5	Headset Jack.....	3
3.6	Connectors.....	3
3.6.1	IO Configuration Port (Dealers only).....	3
3.6.2	PWR (Charging Port).....	3
3.7	Annunciators	4
3.7.1	PWR ON (Power On)	4
3.7.2	LOW BATT (Low Battery Warning).....	4
3.7.3	Battery Charge (not shown).....	4
3.8	Other	4
3.8.1	Pairing Registration Number.....	4
3.8.2	Battery Lid Release	4
3.8.3	Clothing/Mounting Clip	4
4	Pairing and Purging Process.....	5
4.1	Pairing	5
4.2	Purging	6
5	Connecting the wiJAC™ System.....	7
5.1	wiJAC™ Set-up and Connection	7
5.1.1	Insert Batteries	7
5.1.2	Attach JA64 and JA65 Headset Adapters.....	7
5.1.3	Turn On Paired Adapters and Verify Connection.....	7
5.1.4	Verify System Audio Operation.....	7
5.2	wiJAC™ System Operation	8
5.2.1	Listening Operation	8
5.2.2	VOX Speaking Operation	8
5.2.3	ICS PTT Speaking Operation	8
5.2.4	Live Speaking Operation	8
5.2.5	Low Battery Warning	8
5.2.6	Operation during Charging	8
5.2.7	Loss of Audio.....	9
5.2.8	Battery Life	9
6	Batteries	10
6.1	Inserting or Replacing the Batteries.....	10
6.2	Charging Batteries in the Unit.....	10



Table of Contents (Cont.)

6.3	Charging Operation – via Battery Charger	11
6.4	Battery Cautions and Warnings	11
7	Accessories	12
7.1	JA72-005 Glove Box with USB connector	12
7.2	ProCS™ Product Configuration Software.....	12
7.3	Battery Charger Recommendations	12
8	Warranty.....	13
9	FCC Compliance Statement.....	13



1 Introduction

This manual contains the operating instructions for the **wiJAC-Pxx** Wireless Stand Alone Intercom System. The diagram below describes the naming method for the different systems.

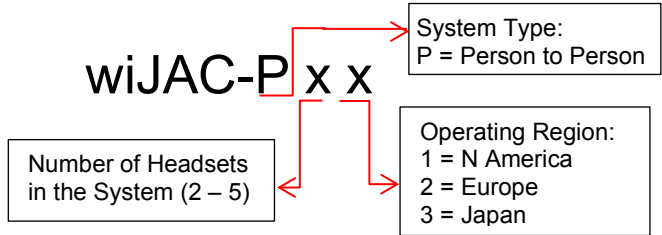

The **wiJAC-Px1** – *N America* consists of one JA65-001 Headset Adapter Master, and up to four JA64-001 Headset Adapter Slaves.

The **wiJAC-Px2** – *Europe* consists of one JA65-002 Headset Adapter Master, and up to four JA64-002 Headset Adapter Slaves.

The **wiJAC-Px3** – *Japan* consists of one JA65-003 Headset Adapter Master, and up to four JA64-003 Headset Adapter Slaves.

Only paired units will operate together (see [section 4](#))

System operating information is in [section 5.2](#).



WARNING: JAC recommends that no battery operated device should be relied upon as the sole method of communication in cases where there is potential risk to life or limb.

1.1 Unpacking

Unpack the **wiJAC™** box carefully, and ensure that it contains the following:

- one Wireless Headset Adapter Master, JAC P/N JA65-00x
- one to four Wireless Headset Adapter Slaves, JAC P/N JA64-00x
- one set of AAA rechargeable batteries for each unit
- one USB to Micro USB cable, JAC P/N CAB-USB-0003 for each unit.
- one **wiJAC™** Quick Start User Guide, JAC P/N DOC-GUID-WIPXXU
- one **wiJAC™** Quick Start Pairing Guide, JAC P/N DOC-GUID-WIPXXP



1.2 Verify Operating Region

The **wiJAC-Pxx** Wireless Intercom System operates using radio frequencies that are authorized by government regulatory agencies. Ensure the region in which you are operating the units matches the region marked on a label on the back of each unit.



2 Headset Adapter Master/Slave (JA65/JA64)



Note: The JA65 Headset Adapter Master and JA64 Headset Adapter Slave are superficially identical except for the colour of the ON/OFF  button and MSTR (master) or SLAV (slave) on the blanking plate. Each system **MUST** utilize one JA65 (green  button).

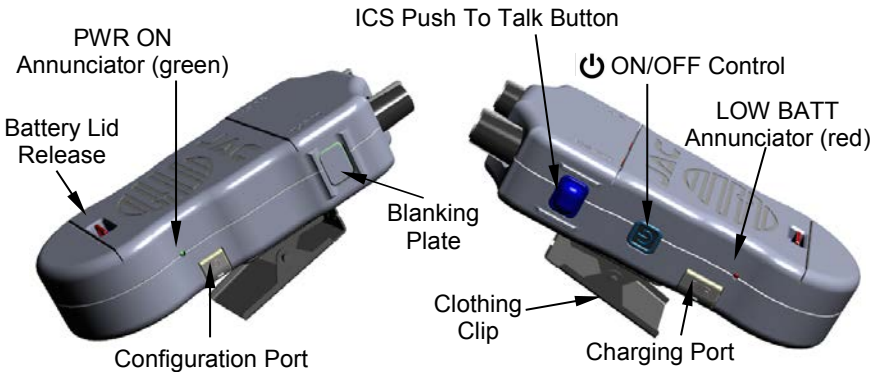

Fig 2-1, Right Side View

Fig 2-2, Left Side View

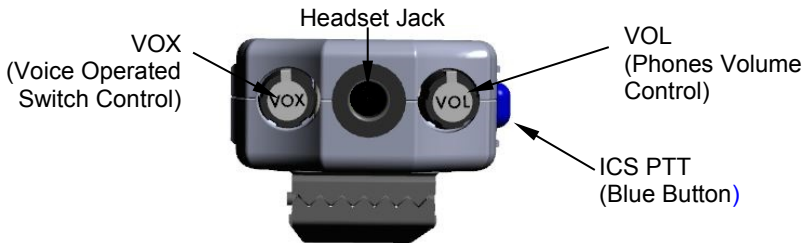



Fig 2-3, Top View



Note: The units are shown in grey for clarity

3 Controls, Annunciators and Connectors

3.1 (ON/OFF) Button

The ON/OFF control is a push button switch marked with the  symbol and is located on the left side of the unit. To turn the unit on, press the ON/OFF button once. To turn the unit off, press and hold the ON/OFF button until the PWR ON and LOW BATT annunciators turn off (approximately three to five seconds).

The JA65 Headset Adapter Master has a **GREEN** ON/OFF button, and the JA64 Headset Adapter Slave has a **GREY** ON/OFF button. Each system must utilize one JA65 (Green  button).



3.2 VOX (Voice Operated Switch)

The Voice Operated Switch control is a rotary knob marked VOX located on the top of the Headset Adapter. To reduce the level of the sound needed to route the microphone audio to the other headset adapter(s), turn the VOX knob counterclockwise (ccw). To increase the level of the sound needed, turn the VOX knob clockwise (cw). Adjust this setting for proper VOX operation as ambient noise levels change.

3.3 VOL (Phones Volume Control)



WARNING: Loud noise can cause hearing damage. Before using a headset, set the volume to minimum, and then slowly increase it to a comfortable listening level.

The volume control is a rotary knob marked VOL (volume) located on the top of the headset adapters. To reduce the volume of the audio heard in the headset rotate the VOL knob ccw. To increase the volume of the audio heard in the headset rotate the VOL knob cw.

3.4 ICS PTT (Push To Talk) Button

The intercom Push To Talk button is a blue convex push button switch located on the left side of the Headset Adapter. The ICS PTT markings are located on the back and front of the unit. When the ICS PTT button is pressed and held, the VOX threshold is overridden, and microphone audio is routed to any other paired headset adapter(s).

3.5 Headset Jack

The headset jack is a TJT120 type connector on the top of the headset adapters. Insert a U-174/U or U93A/U type Headset plug into the headset jack.

3.6 Connectors

3.6.1 IO Configuration Port (Dealers only)

This port is used by Approved dealers and installers to connect the unit to a laptop or PC to enable configuration changes using the ProCS™ program.

3.6.2 PWR (Charging Port)

The Charging Port is a Micro-USB connector with a flexible cover labeled PWR (power) on the left side of the unit. To charge NiMH batteries, connect a USB (Universal Serial Bus) to Micro USB cable from the Charging Port to a USB power source.



WARNING: Charging battery types other than NiMH or NiCad may cause the batteries to leak or explode and cause damage or injury. If non-NiMH or non-NiCad batteries are installed, do not connect the Charging Port to a USB power source.



3.7 Annunciators

3.7.1 PWR ON (Power On)

The power on (PWR ON) annunciator is a green LED located on the right side of the unit. In addition to indicating that the unit is turned on, this annunciator indicates the connection status of paired units (see [section 4.1](#))

3.7.2 LOW BATT (Low Battery Warning)

The low battery (LOW BATT) annunciator is a red LED located on the left side of the unit. When a unit is turned on, the LOW BATT annunciator will illuminate for 2 seconds.

When the JA64 battery voltage is low the LOW BATT annunciator will flash once every 1.5 s and a low battery notification (a triple beep) will be heard in the headphones once every minute.

When the unit battery charge is less than or equal to the critical battery voltage, the unit will turn off.

3.7.3 Battery Charge (not shown)

The JA64 and JA65 Battery Charge annunciators are two LEDs, one on each side of the charging port under the flexible dust cover marked PWR.

The Fast Charge annunciator is a red light emitting diode (LED) that will illuminate when the batteries are being charged at the maximum charge current.

The Top-Off Charge annunciator is a green LED that will illuminate when Fast Charge mode is complete and the batteries are charged.

3.8 Other

3.8.1 Pairing Registration Number

The pairing registration number is marked on a label in on the back of the JA65. JA64 Headset Adapters must be marked with the same pairing registration number after pairing (see [section 4.1](#)).

3.8.2 Battery Lid Release

The battery lid release is a lever on the front of the unit recessed into the battery lid (see [section 6.1](#)).

3.8.3 Clothing/Mounting Clip

The clothing clip is on the rear of the JA64/JA65 Headset Adapters. Ensure that the units are attached securely.



4 Pairing and Purging Process

The **wiJAC-Pxx** Wireless Intercom Systems consist of one JA65 Headset Adapter Master (green ON/OFF button), and up to four factory-paired JA64 Headset Adapter Slaves. Any additional Headset Adapter Slaves must be paired with the Headset Adapter Master before the expanded system can function correctly. Once pairing is complete, the three character Pairing Registration Number from the back of the JA65 should be written on the label on the back of each paired JA64 using a permanent marker. Ensure that the same number is marked on each unit.

To locate the pair switch, the battery cover must be removed from the unit.



When the battery cover is removed, the pair symbol and switch access hole can be seen on the edge of the compartment. Insert a straightened paperclip into the hole to press the button.

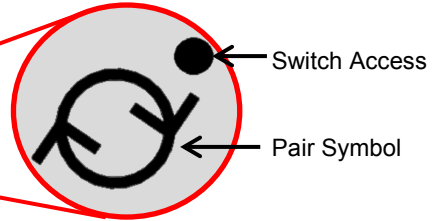

4.1 Pairing

The JA64/JA65 pairing process is described in the following steps:

1. **Turn off the JA65 and any other JA64 previously paired with the JA65.**
2. **Turn on the JA65.**
The JA65 enters the standby mode (Power Annunciator blinks in sets of two or three flashes). If the Power Annunciator stays on continuously, there is a JA64 still powered on and connected to the JA65. Please turn off the JA64.
3. **On the JA65, press and hold the Pair Switch (4 seconds) until the Power and Low Battery Annunciators start flashing rapidly (10 flashes /second). Release the Pair switch.**
The JA65 enters the pairing mode (Power Annunciator is flashing at a medium rate (5 flashes /second) and can now be paired with a JA64.
4. **Turn on a JA64 to be paired with the JA65.**
The JA64 enters the standby mode (Power Annunciator blinks in sets of two or three flashes).
5. **On the JA64, press and hold the Pair Switch (4 seconds) until the Power and Low Battery Annunciators starts flashing rapidly (10 flashes /second). Release the Pair switch.**
The JA64 enters the pairing mode (Power Annunciator is now flashing at a medium rate (5 flashes /second) and will complete the pairing process automatically with the JA65.

The JA64 and JA65 indicate they have completed the pairing process when the Power Annunciator is on continuously.



4.2 Purging

A JA65 that has already been paired with four JA64 headset adapters must be purged to clear any existing pairings if it is necessary to replace one or more of the headset adapters.



Note: This process clears ALL previously paired units from the JA65. All JA64 units required for use in the system must then be paired with the JA65.

The purging process is described in the following steps:

- 1. Turn off the JA65 and any other JA64 previously paired with the JA65.**
- 2. Turn on the JA65.**

The JA65 enters the standby mode (Power Annunciator blinks in sets of two or three flashes). If the Power Annunciator stays on continuously, there is a JA64 still powered on and is connected to the JA65. Please turn off the JA64.
- 3. On the JA65, press and hold the Pair Switch (>8 seconds) until the Power and Low Battery Annunciators turn off. Release the Pair switch.**

The JA65 enters the purge mode (Power Annunciator blinks in sets of three flashes). Wait for the JA65 to finish purging all paired JA65 from its memory (approximately 10 seconds).
- 4. Turn off the JA65.**
- 5. Turn on the JA65. If the Power Annunciator blinks in sets of three flashes, the purging process was successful. If the Power Annunciator blinks in sets of two flashes, repeat the purging process from step 1.**



CAUTION: To minimize the risk of system malfunction, a JA64 must not be paired with more than one JA65 at a time.



5 Connecting the wiJAC™ System



Note: The **wiJAC**-Pxx Wireless Intercom System Person to Person consists of one JA65 Headset Adapter Master and up to four JA64 Headset Adapter Slaves. Only paired units will operate together (see [section 4](#)).

A headset is inserted into the jack on the JA64/JA65 Headset Adapter, which is clipped to the user's belt or clothing. **Headsets are not included.**

5.1 wiJAC™ Set-up and Connection

5.1.1 Insert Batteries

Ensure the batteries for all units are fully charged and installed in the battery compartment with the correct polarity, and the battery lid is secured (section 6).

5.1.2 Attach JA64 and JA65 Headset Adapters

Insert a headset with a U-174/U or U93A/U type plug into the JA64/JA65 Headset Adapter jack.

5.1.3 Turn On Paired Adapters and Verify Connection

On the JA65 Headset Adapter Master, turn the VOL knob fully counterclockwise to minimum. Turn on the JA64 Headset Adapter Slave(s). On all units, the PWR ON and LOW BATT annunciators will illuminate for two seconds.

- When a unit is turned on, the PWR ON annunciator will illuminate for 2 seconds, and the unit will start to search for its paired unit.
- While the unit is searching for its paired unit the PWR ON annunciator will triple-flash every 1.5 seconds.
- When the unit is connecting to its paired unit, the annunciator will double-flash every 1.5 s until connection is established.
- After connection, the annunciator will illuminate steady green until the unit is turned off.

5.1.4 Verify System Audio Operation

Adjust VOX control on the JA64 and JA65 Headset Adapters fully ccw and rotate the VOL control to achieve a comfortable listening level. Confirm that the microphone audio is live - all microphone audio is heard in the paired JA64/JA65 phones. Confirm that the audio level increases as the VOL control is rotated clockwise and decreases as the VOL control is rotated counterclockwise.

Adjust VOX control on the JA64/JA65 Headset Adapters fully clockwise and confirm that the microphone audio is off. Adjust the Headset Adapter's VOX control for a comfortable speaking level.

Press the JA64 or JA65 Headset Adapter's ICS PTT button and confirm that microphone audio is heard in all the paired JA64/JA65 phones.



5.2 wiJAC™ System Operation



Note: Operation for the JA64 Slave and JA65 Master Headset Adapters is identical, but each system MUST contain a JA65 Master (green ON/Off button).

5.2.1 Listening Operation

The Headset Adapter Phones Volume (VOL) controls the level of audio heard in the headset's ear phones. As ambient noise levels change, the volume can be adjusted.

5.2.2 VOX Speaking Operation

To use the JA64/JA65 Headset Adapter hands-free, adjust the VOX control so that the microphone audio is turned on when speaking into the headset's microphone at a comfortable level, or at a level to keep the ambient noise from turning on the microphone audio.

5.2.3 ICS PTT Speaking Operation

To use the JA64/JA65 Headset Adapter in high-noise environments, adjust the VOX control fully clockwise. To communicate, press and hold the ICS PTT button and speak in to the headset's microphone.

5.2.4 Live Speaking Operation

To use the JA64/JA65 Headset Adapter so that the microphone audio is always turned on, adjust the VOX control fully counterclockwise.

5.2.5 Low Battery Warning

When the unit's battery charge is low, the LOW BATT annunciator will flash every 1.5 seconds. When the JA64 Headset Adapter battery charge is low, a triple-beep will be heard in the headset once every minute.



Note: JAC recommends that the batteries should be charged or replaced immediately when the LOW BATT warning illuminates during use.

When the battery charge level is critical, the unit will turn off. When one unit is off the other unit will begin searching for its paired unit and its PWR ON annunciator will flash.

5.2.6 Operation during Charging

The units will still operate while the Charging Port is connected to a USB power source, but the batteries will charge at a slower rate. Additional noise may be heard on the audio system while the Charging Port is connected to a USB power source.



5.2.7 Loss of Audio

If there is no audio heard in the headset, check the PWR ON annunciator on the JA64 and the JA65 Headset Adapters. If a unit is off, turn it on and verify connection and operation.

If the battery charge is low, replace or recharge the batteries or remove the wiJAC system.

If audio is unintelligible, discontinue use of the wiJAC system until troubleshooting can be carried out.

5.2.8 Battery Life

The operating duration of the **wiJAC-Pxx** system with fully charged batteries before battery replacement is required depends on the following factors:

- **Distance between Headset Adapter Master and Headset Adapter Slaves:**
The closer together the units are the lower the radio frequency (RF) power required for connection. This will increase the battery life.
- **Obstacles between the Headset Adapter Master and Headset Adapter Slaves:**
Minimising the aircraft metal structures, human bodies, cargo and other obstacles between the units will reduce the RF power needed for connection and increase the battery life.
- **Charge capacity of the batteries installed:**
The higher the capacity of the batteries, typically specified as 500 to 1000 mAh (milliamp-hours), the longer the battery life.
- **The type of batteries installed and the operating temperature:**
During low temperature operation, rechargeable batteries will lose capacity. When operating in low temperatures use alkaline batteries for a longer battery life.
- **The phones volume level and usage rate:**
The lower the volume level and the less often audio is output to the phones, the longer the battery life.



6 Batteries



WARNING: Charging battery types other than NiMH or NiCad may cause the batteries to leak or explode and cause damage or injury. If non-NiMH or non-NiCad batteries are installed, do not connect the Charging Port to a USB power source.

The JA64 and JA65 each require three AAA batteries. JAC recommends Duracell 800 mAh (or higher) NiMH or Duracell alkaline batteries for use in the wiJAC™ system to obtain the typical battery life.

Removal of the batteries WILL NOT change any internal configuration of the unit.



Note: Rechargeable batteries MUST be charged before first use.

6.1 Inserting or Replacing the Batteries

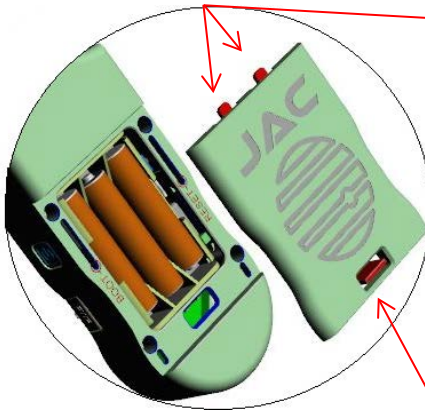

Retaining tabs

To replace the batteries (both units the same), remove the battery cover by pressing the battery lid release towards the JAC logo, lifting the lower end of the cover, and then gently prying the lid up and away from the body to release the two tabs from the retaining slots.

Remove the batteries and insert fully charged batteries, matching the polarity marked on the battery holder.

Battery Lid Release

6.2 Charging Batteries in the Unit

To charge rechargeable batteries in the unit, connect the Charging Port to a USB power source using the USB to Micro-USB cable (CAB-USB-0003). If turned on during charging, the unit draws its power from the charging source, not the batteries, but battery charging will take longer. When charging is complete, the 'Top Off' Charge annunciator will illuminate green.

It should be possible to charge the unit via most USB power sources but this cannot be guaranteed for any products not made by or purchased from JAC. Where space allows, JAC recommends the JAC JA72-006 6 Dzus Glove Box with USB connector (see [section 7.1](#))



Note: The batteries will charge whether the JA64/JA65 is switched on or switched off. Battery charging will take longer if the unit is switched on.



6.3 Charging Operation – via Battery Charger

The batteries may be removed from the unit for charging in a separate battery charger. Removal of the batteries WILL NOT change any internal configuration of the unit.



Note: The JA64 and JA65 will only charge the batteries when the internal temperature is within 0 to 40 °C

6.4 Battery Cautions and Warnings



CAUTION: Follow these guidelines to prolong battery life and minimize the risk of unit malfunction.

- ⚠ Do not leave batteries uncharged for long periods of time.
- ⚠ Do not leave batteries charging for extended periods (more than 48 hours)
- ⚠ To ensure that the unit functions correctly, insert the new batteries with the positive and negative poles aligned as indicated in the battery compartment.
- ⚠ When replacing the batteries, use only new or fully charged batteries.
- ⚠ Do not mix old and new batteries as this can cause battery leakage and/or damage to the unit.
- ⚠ Do not mix battery types.



WARNING: Follow these guidelines to prolong battery life, and minimize the risk of fire, chemical burns, electrolyte leaks and/or injury.

- ❗ **FOLLOW** the manufacturer's instructions for care and disposal of batteries.
- ❗ **DO NOT** use sharp objects to remove the batteries.
- ❗ **DO NOT** disassemble, puncture, burn or in any other way damage the batteries.
- ❗ **DO NOT** let children handle the batteries.
- ❗ **USE ONLY** recommended battery chargers.
- ❗ **USE ONLY** recommended replacement batteries.



7 Accessories

7.1 JA72-005 Glove Box with USB connector



The JA72 Glove Box with USB Charger allows an aircraft owner/operator to utilize an empty portion of the instrument panel for storage.

A USB 2.0 Type A receptacle is provided to supply 5 Vdc power up to 2 Amps, and a 3.5mm stereo jack can be connected to the aircraft's audio system.

7.2 ProCS™ Product Configuration Software

ProCS™ Product Configuration Software and a ProCS™ connection cable are available to approved dealers and installers.

7.3 Battery Charger Recommendations

To charge AAA NiMH batteries, JAC recommends the charger should have individual cell charging (so that three batteries may be charged at once), an automatic shut-off feature and a charge time of two to six hours.

Always follow the manufacturer's recommendations for use of batteries and battery chargers.



8 Warranty

Locate and complete the online warranty registration form from the JAC website:
www.jupiteravionics.com/warrantyregistration

These products manufactured by JAC are warranted to be free of defects in workmanship or performance for 1 year from the date of purchase from an authorized JAC dealer. This warranty covers the cost of all materials and labour to repair or replace the unit, but does not include the cost of transporting the defective unit to and from JAC or its designated warranty repair centre. This warranty does not cover failures due to abuse, misuse, accident, incorrect battery use/installation, or unauthorized alteration or repairs.

Contact JAC for any questions regarding this warranty and how it applies to your unit(s). JAC is the final arbiter concerning warranty issues.

Contact JAC for a Returned Materials Authorisation Form (RMA) prior to shipping any products for repair. This form can be downloaded from our website at
www.jupiteravionics.com/dealersrmaform

9 FCC Compliance Statement

This device complies with Part 15 of the FCC Rules.

Operation is subject to the following two conditions:

- 1) this device may not cause harmful interference, and
- 2) this device must accept any interference received, including interference that may cause undesired operation of the device.

Module transmetteur ID IC: 9576A-SC14A

Son fonctionnement est soumis aux deux conditions suivantes:

- 1) cet appareil ne doit pas causer d'interférences nuisibles et
- 2) cet appareil doit accepter toute interference recue, y compris les interferences qui peuvent perturber le fonctionnement.

Changes or modifications to the equipment not expressly approved by the Party responsible for compliance could void the user's authority to operate the equipment.

NOTE: This equipment has been tested and found to comply with the limits for a Class B digital device, pursuant to Part 15 of the FCC Rules. These limits are designed to provide reasonable protection against harmful interference in a residential installation.

This equipment generates, uses and radiates radio frequency energy and, if not installed and used in accordance with the instructions, may cause harmful interference to radio communications. There is no guarantee that interference will not occur in a particular installation. If this equipment does cause harmful interference to radio reception, which can be determined by turning the equipment off and on, the user is encouraged to try to correct the interference by one or more of the following measures:

- Increase the separation between the equipment and the interfered receiver or antenna.
- Turn the equipment off and remove from the aircraft.
- Consult Jupiter Avionics Corp or an experienced avionics technician for help.



Note: Privacy of communications may not be ensured when using this equipment.



JUPITER AVIONICS
CORPORATION

Jupiter Avionics Corporation
1959 Kirschner Road
Kelowna BC
Canada V1Y 4N7
Tel: +1 778 478 2232
Toll-Free: 1 855 478 2232
www.jupiteravionics.com



JUPITER AVIONICS

C O R P O R A T I O N

wiJAC-Pxx

Stand-Alone (*non-aircraft*) Wireless Intercom System

Data Sheet



Description

The wiJAC-Pxx system is a Stand-Alone Wireless Intercom System for up to five users, and provides a wireless full-duplex, hands-free audio network. The components connect to standard aircraft headsets and attach to the users' belts, allowing operators free movement. Adapters are available for different headset connector styles and impedances.

Communications range is typically 100 meters (200 meters for European model). The system features only essential controls to ensure ease of operation. (VOX and Volume control knobs, and On/Off and PTT buttons)

The wiJAC-Pxx system is designed to operate independently, and does not use any aircraft audio connections.

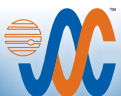

1959 Kirschner Rd, Kelowna, BC V1Y 4N7, Canada
Tel: +1 778-478-2232 Toll-Free 1 855-478-2232

www.jupiteravionics.com



Features

The wiJAC™ system is factory programmed with default settings that are suitable for most general (aviation-type) high impedance headsets. If it is necessary to modify the balanced phones/microphone input/output levels, this can be carried out by a JAC Dealer using JAC's proprietary ProCS™ software. A configuration port is provided to support this function.

A light on each unit indicates when the RF communication link is established, and a micro USB charging port is provided for connection to a USB charging source. Charging cables and rechargeable batteries are included with each system.

Multiple systems can be co-located without interference. An encrypted radio link ensures secure communications. The units are designed for NATO style aircraft connectors. A selection of adapter cables is available for use with other connector styles.

The wiJAC-Px1 system comprises a JA65-001 and a number of JA64-001's and is for use in North America. The wiJAC-Px2 system comprises a JA65-002 and a number of JA64-002's and is for European use.

wiJAC™ -Pxx Specifications Installation

U-92A/U type connector mates with U93A/U and equivalent

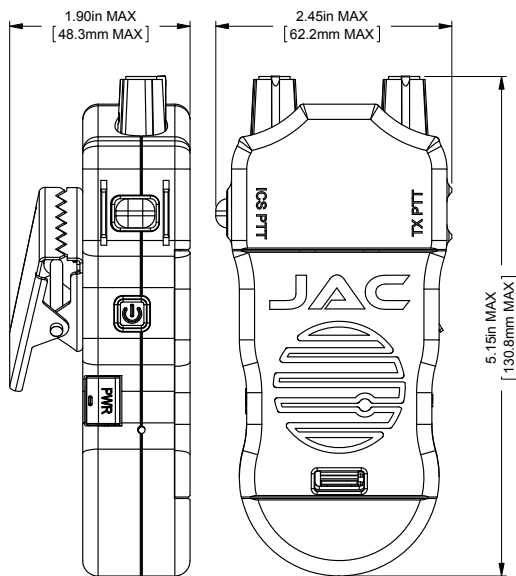

JA65-00x Wireless Aircraft Headset Adapter
Weight: 0.46 lb. 0.209 Kg Max

U-92A/U type connector mates with U93A/U and equivalent

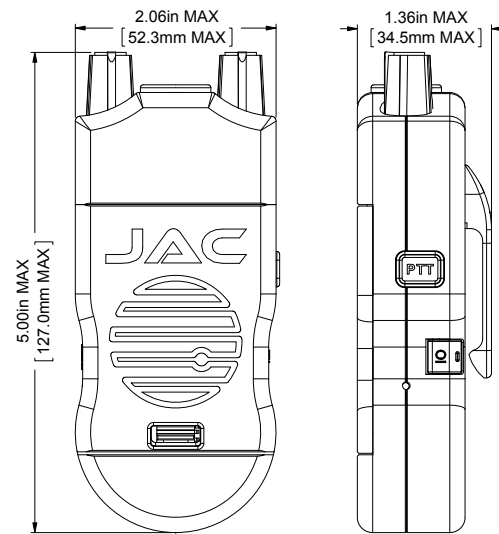

JA64-00x Wireless Aircraft Headset Adapter
Weight: 0.39 lb. 0.178 Kg Max

Environment and Performance

Batteries	AAA (3 per unit)
Charging Electrical Power	+5 Vdc @ 200mA max (USB Power Source)
Temperature	-15 °C to +50 °C -40 °C to +50 °C
Altitude	25,000 ft. max
Humidity	95%
Microphone	150 Ohms amplified Dynamic

Vibration	Per DO160G Cat [(SBM)(U2FF1)]
Range wiJAC-Px1	100 m (typical)
Range wiJAC-Px2	200 m (typical)
Battery Life	6 to 8 hr (typical)
Shock	20g (any axis)
Headphone	100 mW into 150 Ohms